



Set-D

ELECTRICAL ENGINEERING

SECTION-I

QUESTION NUMBER 1-20

CARRY 1 MARK EACH

- The main scale of a vernier calliper is ruled in 1 mm units. The vernier scale is 49 mm long and divided in 50 units. The resolution of the vernier calliper is
 - 0.002 mm
 - 0.005 mm
 - 0.01 mm
 - 0.02 mm
- A frequency counter with a gating time of 50 ms counts 1254 cycles of an input square wave. The frequency of the input wave is
 - 39.87 Hz
 - 62.70 Hz
 - 1.254 kHz
 - 25.08 kHz
- A data acquisition system with the input range of ± 5.0 V has a 12-bit ADC in it. The resolution of the system is approximately
 - 0.24 mV
 - 0.48 mV
 - 1.22 mV
 - 2.44 mV
- Wattmeters are based on the principle of
 - permanent magnet moving coil meter
 - electrodynamometer meter
 - electrostatic meter
 - moving iron meter
- The resolution of a Gray-coded optical shaft encoder with 10-bit output is approximately
 - 0.098°
 - 0.176°
 - 0.225°
 - 0.352°
- If $y(t) \leftrightarrow Y(s)$ indicates a Laplace transform pair, then $y(t)$ for $t \geq 0$ when $Y(s) = \frac{3 - 3e^{-2s}}{(s+2)(s+3)}$ is ()
 - $[3e^{-2t} - 3e^{-3t}]$
 - $[3e^{-2(t-2)} - 3e^{-3(t-2)}]u(t-2)$
 - $[3e^{-2t} - 3e^{-3t}][3e^{-2(t-2)} - 3e^{-3(t-2)}]$
 - $[3e^{-2t} - 3e^{-3t}] - [3e^{-2(t-2)} - 3e^{-3(t-2)}]u(t-2)$
- The undamped natural frequency in rad/s and the damping ratio of the system with the transfer function $G(s) = \frac{s^2 + 64}{s^2 + 12s + 100}$ are, respectively,
 - 10 and 1.2
 - 10 and 0.6
 - 8 and 1.2
 - 8 and 0.75
- The gain at the breakaway point of the root locus along the real axis of a unity feedback system with the transfer function $G(s) = \frac{K}{s^2 + s - 1}$ is
 - $K = 0$
 - $K = 0.5$
 - $K = 1$
 - $K = 1.25$
- Gain margin of the unity feedback system with the loop transfer function $G(s) = \frac{100}{(s+1)^3}$ is
 - 35.35
 - 12.5
 - 0.08
 - 0.03
- The discrete time system with the transfer function $G(z) = \frac{1}{z^3 + 0.4z^2 - 0.25z - 0.1}$ is
 - stable
 - unstable
 - marginally stable
 - sustained oscillatory
- The unit of the permittivity of free space (ϵ_0) is
 - $C^2 N^{-1} m^{-2}$
 - $C^2 N m^2$
 - $C^{-2} N m^2$
 - $C^{-2} N m^{-1}$
- A positively charged object is placed in the centre of a room with a uniform magnetic field. If the magnetic field is pointing east, the object will
 - move east
 - move north
 - move south
 - remain stationary
- The input impedance of a quarter-wave long short-circuited lossless transmission line is
 - purely reactive
 - purely resistive
 - infinite
 - dependent on the characteristic impedance of the line
- For a plane wave propagating in the free space,

- a. the electric and magnetic fields are in parallel to the direction of propagation there is no field in the direction of propagation
- b. the electric and magnetic fields are out of phase
- c. the magnetic field amplitude is inversely proportional to the electric field amplitude
15. Which of the following materials has the largest energy gap between the conduction band and the valence band?
- a. Gold
- b. Silicon
- c. Doped germanium
- d. Porcelain
16. The area of hysteresis loop in a ferromagnetic material is a measure of
- a. loss of energy
- b. loss of magnetic domain
- c. loss of magnetic dipole
- d. loss of eddy currents
17. If a tetra-valent impurity is added to a pure silicon crystal at room temperature, it becomes
- a. a p-type semiconductor
- b. an n-type semiconductor
- c. an npn-type semiconductor.
- d. an insulator

18. The circuit shown in Fig. I.18 has the following source values:
 $V_A = 600 t u(t+1)$ V, $V_B = 600(t+1) u(t)$ V and $I_C = 6(t-1) u(t-1)$ A, where $u(\cdot)$ denotes the unit step function. For this circuit, the current i at $t = -0.5$ s will be

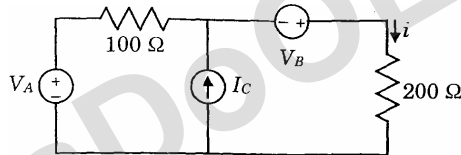

Fig. I.18

- a. -9 A
- b. -6 A
- c. -1 A
- d. 0 A
19. Assuming the transformer in Fig. I.19 ideal, the effective value of the load seen by the source is

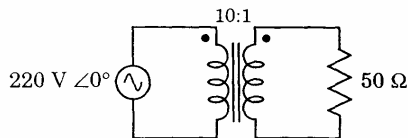

Fig. I.19

- a. 0.5 Ω
- b. 50 Ω
- c. 500 Ω
- d. 5000 Ω
20. If an electrical transformer and a mechanical gear system are considered analogous to each

other, the equivalent quantity of the transformer primary voltage in the gear system will be

- a. angular speed
- b. displacement
- c. torque
- d. moment of inertia

QUESTION NUMBER 21-50

CARRY 2 MARKS EACH

21. If a unit ramp input $v(t)$ is applied to the circuit shown in Fig. I.21, then the steady state value of the output will be

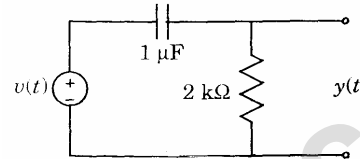

Fig. I.21

- a. 0.002
- b. 5
- c. 500
- d. 2000

22. An analog dc ammeter of full scale current of 1 mA is obtained by connecting a shunt resistor of 11 Ω in parallel with a galvanometer having a full scale current of 100 μ A. The value of shunt resistor required for obtaining an ammeter of full scale current of 10 mA using the same galvanometer is

- a. 0.9 Ω
- b. 1.0 Ω
- c. 1.1 Ω
- d. 10.0 Ω

23. An average responding analog ac voltmeter using half wave rectifier to read RMS value of the input sinusoidal voltage. If the meter reads 24 V for a square wave input with zero mean, the actual RMS value of the input is

- a. $\frac{24\sqrt{2}}{\pi}$ V
- b. $\frac{24}{\sqrt{2}}$ V
- c. $\frac{48\sqrt{2}}{\pi}$ V
- d. $\frac{24\pi}{\sqrt{2}}$ V

24. A resistance is measured by the voltmeter-ammeter method. The voltmeter reading is 25 V on the 100 V scale and the ammeter reading is 250 mA on the 500 mA scale. Both meters are accurate within ± 1 per cent of full-scale reading. The maximum possible error, in percent of measured value of the resistor is

- a. $\pm 2\%$
 b. $\pm 2.5\%$
 c. $\pm 4\%$
 d. $\pm 6\%$
25. An energy meter makes 200 revolutions of disc per unit of energy. The meter is tested by connecting to a load of 20 A at pf 0.8 lagging in 250 V mains for one hour. If the observed number of revolutions is 760, the percentage error in the meter is
- a. 0.5% fast
 b. 2.5% fast
 c. 5% slow
 d. 25% slow

26. The ac bridge given in Fig. I.26 is balanced at $\omega = 1000$ rad/s. The value of the unknown inductor L is

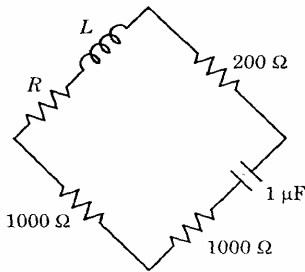

Fig. I.26

- a. 1 H
 b. 0.1 H
 c. 0.5 mH
 d. 0.2 mH
27. An RTD having a sensitivity of $0.4 \Omega/^\circ\text{C}$ is connected in a dc bridge having 100Ω fixed resistors in other three arms. The bridge supply is 5.4 V with the RTD connected to zero potential and the bridge is balanced at 0°C . At room temperature the bridge unbalanced output voltage is 0.2 V with the RTD side of the output being positive. The room temperature is
- a. 6.4°C
 b. 15°C
 c. 25°C
 d. 40°C
28. The volumetric flow rate (Q) for a turbine flowmeter with 8 blades in the rotor is given by $Q = k\omega$, where the constant $k = 2 \times 10^{-5} \text{ m}^3/\text{rad}$ and ω is the rotor angular velocity in rad/s. If a proximity device used to pick-up presence of rotor blades gives output of 48 pulses/s, the flow rate is
- a. $3\pi \times 10^{-5} \text{ m}^3/\text{s}$
 b. $24\pi \times 10^{-5} \text{ m}^3/\text{s}$
 c. $9.6\pi \times 10^{-4} \text{ m}^3/\text{s}$
 d. $12\pi \times 10^{-4} \text{ m}^3/\text{s}$
29. Which of the following conditions ensures that exactly two roots of $s^3 + as^2 + s + c = 0$ lie in the right half of the s-plane?

- a. $a > 0, c > 0$ and $a > c$
 b. $a > 0, c > 0$ and $a < c$
 c. $a > 0$ and $c < 0$
 d. $a < 0$ and $c = a$

30. The loop transfer function of a unity feedback system is given by $G(s) = \frac{(s-1)(s+K)}{(s+1)s+4}$. For $0 \leq K \leq \infty$, its root locus starts from
- a. $s = -1$ and $s = -4$
 b. $s = -1 + j$ and $s = -1 - j$
 c. $s = 1$ and $s = -\infty$
 d. $s = -3 + \sqrt{6}$ and $s = -3 - \sqrt{6}$

31. The approximate transfer function of a system with the following frequency response is

ω (radian/s)	0.1	0.3	3	30
Gain in dB	-20	-20.5	-26	-60
Phase in Degree	0	0	-90	-180

- a. $\frac{0.9}{(s+3)^2}$
 b. $\frac{0.9}{s(s+3)}$
 c. $\frac{0.9}{(s+1)s+3}$ ()
 d. $\frac{0.9}{(s+1)s+30}$ ()

32. The diagonal form of the state space representation of a SISO system with the transfer function $\frac{Y(s)}{U(s)} = \frac{3s^2 + 6s + 2}{s^3 + 3s^2 + 2s}$ can be expressed as

- a. $x = \begin{bmatrix} 0 & 0 & 0 \\ 0 & -1 & 0 \\ 0 & 0 & -2 \end{bmatrix} x + \begin{bmatrix} 1 \\ 1 \\ 1 \end{bmatrix} u + \dots$
 $y = [1 \ 1 \ 1]x$
- b. $x = \begin{bmatrix} 0 & 0 & 0 \\ 0 & -1 & 0 \\ 0 & 0 & -2 \end{bmatrix} x + \begin{bmatrix} 1 \\ 1 \\ 1 \end{bmatrix} u + \dots$
 $y = [3 \ 6 \ 2]x$
- c. $x = \begin{bmatrix} 0 & 0 & 0 \\ 0 & -1 & 0 \\ 0 & 0 & -2 \end{bmatrix} x + \begin{bmatrix} 1 \\ 1 \\ 1 \end{bmatrix} u + \dots$
 $y = [0 \ -1 \ 2]x - \dots$

$$d. \quad x = \begin{bmatrix} 0 & 0 & 0 \\ 0 & -1 & 0 \\ 0 & 0 & -2 \end{bmatrix} x + \begin{bmatrix} 1 \\ 1 \\ 1 \end{bmatrix} u$$

$$y = [2 \quad 6 \quad 3]x$$

33. A feed forward controller of the form $G_c(s) = \frac{K(s+a)}{(s+b)}$ is designed for a plant with

the transfer function $G(s) = \frac{1}{s(s+3)}$ such that

the undamped natural frequency and the damping ratio of the closed loop second order system are 2 rad/s and 0.5, respectively. When the steady state error to a unit step input is zero, then the controller parameters are

- $K=4, a=3, b=2$
 - $K=1, a=3, b=2$
 - $K=4, a=2, b=3$
 - $K=1, a=2, b=3$
34. The transfer function of the system with the state space representation

$$x = \begin{bmatrix} 1 & 0 \\ 0 & -1 \end{bmatrix} x + \begin{bmatrix} 0 \\ 1 \end{bmatrix} u; \quad y = [1 \quad 1]x + u$$

- $\frac{1}{(s+1)}$
- $\frac{1}{(s-1)}$
- $\frac{(s+2)}{(s+1)}$
- $\frac{(s+2)}{(s+1)s-1}$

35. The system with the state space representation as given in Q.34 is

- controllable
- observable
- marginally controllable
- not observable

36. Consider a plant transfer function $G(s) = \frac{1}{s}$.

The state feedback gain controller k that places the pole of the regulatory control system at $s = -1$ is given by

- $k=0$
- $k=0.5$
- $k=1$
- $k=2$

37. The state space representation of the system shown in Fig. I.37 can have the state and output equation constants

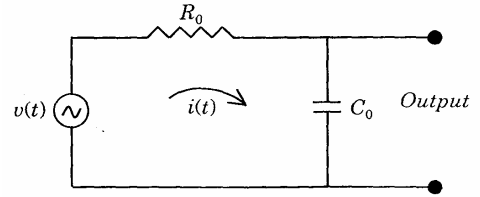

Fig. I.37

- $A = \frac{-1}{R_0}, B = \frac{1}{R_0}, C = \frac{1}{C_0}$
- $A = \frac{-1}{C_0}, B = \frac{1}{R_0}, C = \frac{1}{C_0}$
- $A = \frac{-1}{R_0 C_0}, B = \frac{-1}{R_0}, C = \frac{-1}{C_0}$
- $A = \frac{-1}{R_0 C_0}, B = \frac{1}{R_0}, C = \frac{1}{C_0}$

38. A unit step sequence is applied as the input to a system with the closed loop transfer function

$$T(z) = \frac{4z^2 + 8z - 1}{12z^2 + 5z - 2}$$

The steady state error of the system is

- $\frac{1}{15}$
- $\frac{3}{15}$
- $\frac{4}{15}$
- $\frac{11}{15}$

39. Which of the following field equations indicates that isolated magnetic charges do not exist?

$$a. \quad \iiint_v \text{div } \vec{B} dv = 0$$

$$b. \quad \vec{B} = \frac{\mu_0 I}{4\pi} \int \frac{d\vec{l} \times \vec{r}}{R^2}$$

$$c. \quad \vec{B} - \vec{\nabla} \times \vec{A} = \vec{0}$$

$$d. \quad \vec{\nabla} \times \vec{B} - \mu_0 \vec{J} = \vec{0}$$

40. A transmission line of characteristics impedance of 50Ω is terminated by a load of 75Ω . The VSWR produced by it in the transmission line will be

- 1.2 : 1
- 1.5 : 1
- 2 : 1
- 5 : 1

41. In the Lorentz force law $\vec{F} = Q(\vec{v} \times \vec{B})$,

- \vec{F} must be perpendicular to \vec{v} but not to \vec{B}
- \vec{F} must be perpendicular to \vec{B} but not to \vec{v}
- Lies in the same plane containing \vec{v} and \vec{B}

d. \vec{F} must be perpendicular to the plane containing \vec{v} and \vec{B} .

42. A 1 m long wire with a radius of $\frac{10^{-3}}{\sqrt{\pi}}m$

carries a current of 20 A. If power dissipation along the wire is 4 W/m, the conductivity of the wire (in $\Omega^{-1} m^{-1}$) is

- 4×10^8
- 10^8
- 10^7
- 5×10^8

43. A parallel plate capacitor is made to store 5×10^{-6} C. The separation distance between the plates is 0.3 mm and area of each of the plates is $0.02 m^2$. If vacuum is used as dielectric between the plates, the voltage rating of capacitor is

- 0.118 mV
- 118V
- 8.475 kV
- 8.475 MV

(Given that the permittivity of free space is 8.85×10^{-12} F/m)

44. The value of the load current I_L in Fig. I.44 is

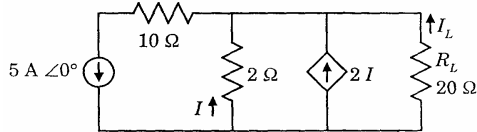

Fig. I.44

- 50/31 A
- 5/11 A
- 5/31 A
- 0 A

45. The current (i_c) through the capacitor in Fig. I.45 is

- 0 A
- $0.625 \sin(200t)$ A
- $0.88 \sin(200t - 45^\circ)$ A
- $1.25 \sin(200t)$ A

46. The capacitor in Fig. I.46 is initially discharged. At $t = 0$ s, the switch is closed. At $t = 100$ ms the current (I_C) through the capacitor is

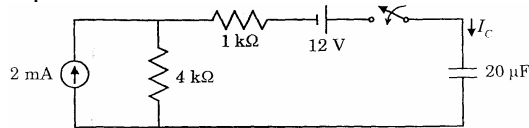

Fig. I.46

- 0 mA
- $\frac{4}{5e} mA$
- $\frac{12}{5e} mA$
- $\frac{4}{e} mA$

47. The switch in Fig. I.47 is closed at $t = 0$ s. At steady state, the current (I_L) through the inductor is

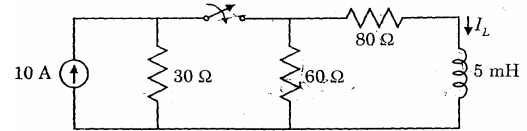

Fig. I.47

- 0 A
- 2 A
- 30/7 A
- 8 A

48. In the circuit shown in Fig. I.48, the Norton equivalent current I_N and resistance R_N between the points a and b are

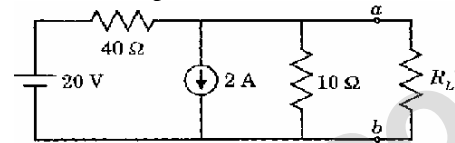

Fig. I.48

- $I_N = -1.5$ A, $R_N = 8 \Omega$
- $I_N = -1.5$ A, $R_N = 10 \Omega$
- $I_N = -2.5$ A, $R_N = 8 \Omega$
- $I_N = -2.5$ A, $R_N = 40 \Omega$

49. The nodal voltage V_1 in Fig. I.49 is

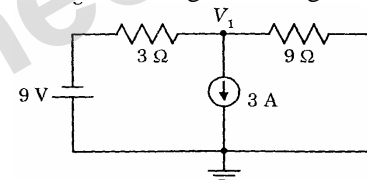

Fig. I.49

- 13.5 V
- 6.75 V
- 4.5 V
- 0 V

50. A balanced 440 V, 3 phase supply is driving a parallel combination of star and delta loads. If both the loads have resistance of 10Ω per phase, the supply current per phase is

- $\frac{44}{\sqrt{3}}$ A
- $44\sqrt{3}$ A
- $\frac{176}{\sqrt{3}}$ A
- $176\sqrt{3}$ A

SECTION-II
QUESTION NUMBER 1-20
CARRY 1 MARK EACH

1. An arithmetic operation in the 8085 microprocessor sets the sign and parity flags. The contents of the accumulator after the execution of the operation can be
 - a. 1011 0100
 - b. 0010 1101
 - c. 1010 1101
 - d. 0110 0111
2. An instruction of the 8085 microprocessor that requires both memory read and memory write machine cycles is
 - a. MVI M, 8F
 - b. LHLD 8088
 - c. RST 1
 - d. ADD M
3. The duration of one T-state in the 8085 microprocessor that uses a crystal of 5.00 MHz is
 - a. 0.2 μ s
 - b. 0.4 μ s
 - c. 2.5 μ s
 - d. 5.0 μ s
4. In a vacuum diode, the discrete nature of electron flow causes
 - a. thermal noise
 - b. white noise
 - c. filtered white noise
 - d. shot noise
5. The rate at which information can be passed through a telecommunication channel depends on the
 - a. JM carrier frequency
 - b. carrier bandwidth
 - c. transmission loss
 - d. transmission power
6. In a commercial TV broadcasting system, the receiver filter structure for the video signal and the frequency gap between audio and video carriers are, respectively,
 - a. VSB, 4.5 MHz
 - b. LPF, 4 MHz
 - c. HPF, 3 MHz
 - d. BPF, 2 MHz
7. The SCR turn-off time increases with
 - a. lower junction temperature
 - b. lower operating frequencies
 - c. lower positive gate biases
 - d. lower peak reverse current
8. The freewheeling diode in a single phase controlled rectifier with inductive load results in
 - a. a small ripple voltage and reduction of reactive power

- b. a large ripple voltage and reduction of reactive power
 - c. a decreased range of firing angle
 - d. a negative average load voltage
9. The chopper circuit shown in Fig. 11.9 operates the motor in quadrants

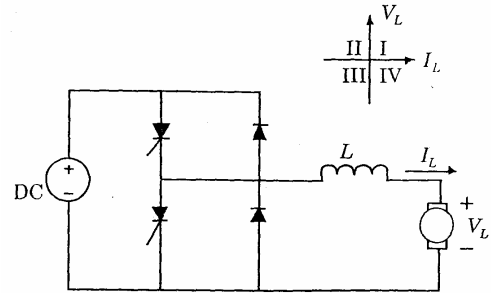

Fig. 11.9

- a. I and II
 - b. II and III
 - c. I and III
 - d. I and IV
10. A 280 V, 10 hp, 4 pole, 60 Hz star connected induction motor has full load slip of 5%. If rotor is blocked, its electrical frequency is
- a. 0 Hz
 - b. 3 Hz
 - c. 50 Hz
 - d. 60 Hz
11. An ideal transformer core should have
- a. high reluctance
 - b. high conductivity
 - c. high permeability
 - d. high permittivity
12. For a 3 phase synchronous generator with zero pf leading load, the terminal voltage due to armature reaction
- a. increases
 - b. decreases
 - c. does not change
 - d. comes down to zero volts
13. Which of the following equipments is generally used for power factor correction in industrial plants?
- a. 3 phase induction motor
 - b. 3 phase synchronous motor
 - c. DC series motor
 - d. DC shunt motor
14. The maximum demand, load factor and the plant rated capacity of a generating station are 100 MW, 0.65 and 130 MW, respectively. The daily energy produced in the station is
- a. 1560 MWhr
 - b. 2028 MWhr
 - c. 2400 MWhr
 - d. 3120 MWhr
15. Which of the following water turbines is of impulse type?
- a. Pelton turbine
 - b. Francis turbine

- c. Kaplan turbine
d. Deriaz turbine
16. The receiving end voltage of a 20 km long overhead transmission line is to be kept constant at 10 kV. Its voltage regulation is 20% with a load. If a capacitor is connected in parallel with the load to reduce the regulation to 10%, the sending end voltage is
- 9 kV
 - 10 kV
 - 11 kV
 - 12 kV
17. For an n-p-n silicon BJT operating in the active region with grounded emitter, if the equivalent base voltage and the equivalent base resistance are 1.7 V and 10 k Ω , respectively, its base current is
- 0.07 mA
 - 0.1 mA
 - 0.17 mA
 - 1 mA
18. The Boolean expression $(A + B)AB$ is equivalent to a two-input
- NAND gate
 - NOR gate
 - X-OR gate
 - X-NOR gate
19. In a multi-stage R-C coupled amplifier, the coupling capacitor
- limits the low frequency response
 - limits the high frequency response
 - does not affect the frequency response
 - blocks the DC components without affecting the frequency response
20. The minimum number of MOS transistors required to make a dynamic RAM cell is
- 1
 - 2
 - 3
 - 4

QUESTION NUMBER 20-50
CARRY 2 MARKS EACH

21. The range of the address of the RAM which is interfaced to a microprocessor as shown in Fig. 11.21 is

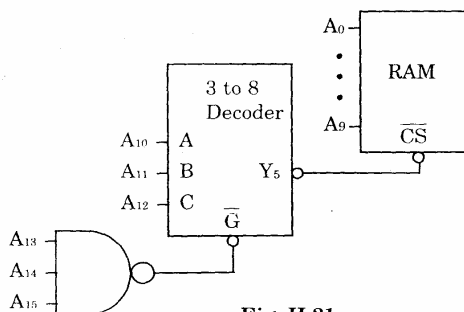

Fig. 11.21

- 1400—17FF
 - E400—EFFF
 - F000—FFFF
 - F400—F7FF
22. After the execution of the following program in the 8085 microprocessor, the contents of the accumulator are
- | Address | Code | Mnemonics |
|---------|----------|------------|
| 203A | 3E 20 | MVI A, 20H |
| 203C | 2A 3A 20 | LHLD 203AH |
| 203F | 86 | ADD M |
| 2040 | 76 | HLT |
- 20H
 - 40H
 - 5EH
 - 7CH
23. For a single tone AM wave, if the modulation index is 1/2, the ratio of the power in the sidebands to that in the entire modulated wave is
- 1/9
 - 1/8
 - 1/4
 - 1/2
24. For a single tone FM wave with a maximum frequency deviation of 75 kHz and the modulation frequency of 15 kHz, the transmission bandwidth is
- 90 kHz
 - 120 kHz
 - 150 kHz
 - 180 kHz
25. If the codeword length of a PCM system is increased from 8 bits to 9 bits, the corresponding signal to quantization noise ratio gets improved by
- 0 dB
 - 6 dB
 - 8 dB
 - 9 dB
26. In time division multiplexing (TDM),
- input and output commutators need not be synchronized
 - each signal is sampled below Nyquist rate
 - different signal samples are interleaved and a single composite signal is transmitted over the channel
 - the signals are collected at the receiving end without any filtering
27. A half-wave controlled rectifier connected to a sinusoidal input source of peak amplitude 300 V supplies power to a resistive load at a firing angle of 120°. The ratio of its average load voltage to the supply peak voltage is
- $\frac{1}{4\pi}$
 - $\frac{1}{2\pi}$

- c. $\frac{1}{\sqrt{2}\pi}$
 d. $\frac{\sqrt{2}}{\pi}$

28. A fully controlled bridge rectifier with resistive load is connected to a Y-Y transformer having RMS value of the secondary from phase to neutral of 300 V. If the firing angle is 30° , then average load voltage will be

- a. 607.70 V
 b. 350.86 V
 c. 248.09 V
 d. 202.57 V

29. A 1-phase to 1-phase cycloconverter is having a resistive load connected to the centre tap of the secondary of the source transformer. The input source gets short circuited when

- a. firing angle of each thyristor is 0°
 b. firing angle of each thyristor is 90°
 c. load voltage frequency is not a submultiple of the source voltage frequency
 d. load voltage frequency is submultiple of the source voltage frequency

30. A multiple rectangular pulse-modulated inverter with 250V and 50 Hz has 20 pulses per cycle locked with the inverter output frequency. The frequency of pulses is

- a. 1000 Hz
 b. 500 Hz
 c. 250 Hz
 d. 50 Hz

31. Fig. II.31 shows the circuit of an ideal chopper. Assuming no ripple in the output and the duty cycle of the switch to be D, the average load voltage across the load R_L becomes

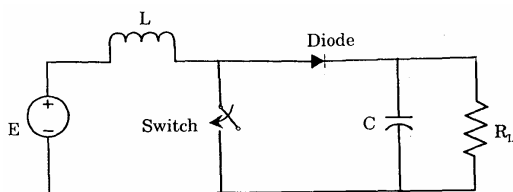

Fig. II.31

- a. E
 b. DE
 c. $E/(1-D)$
 d. $E(1-D)$

32. Fig. II.32 shows a switched capacitor where the switches S_1 and S_2 are alternatively closed and opened at a frequency of 1 kHz.

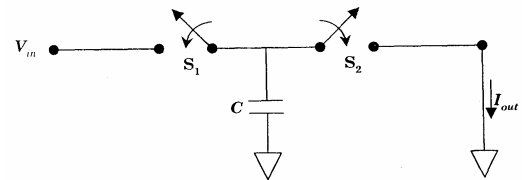

Fig. II.32

If the capacitor rating is $C = 1\mu\text{F}$, then the equivalent resistance becomes

- a. 0.001Ω
 b. 1Ω
 c. 100Ω
 d. 1000Ω

33. A 400 V, 60 Hz, 3 phase induction motor is drawing 60 A at 0.85 pf lagging. The stator and the rotor copper losses are 2 kW and 1 kW, respectively. If the core losses are 1.5 kW then the air gap power is

- a. 30.83 kW
 b. 31.83 kW
 c. 37.44 kW
 d. 57.69 kW

34. A 500 kVA, 11000/400 V tap changing transformer is used to regulate the voltage in a distribution network. The voltage ratio of this transformer at 2% tap change is

- a. 11220/408
 b. 11220/400
 c. 220/8
 d. 10780/392

35. A long shunt DC compound generator drives parallelly connected 20 lamps, each having a resistance of 500Ω . The terminal voltage, shunt resistance, armature resistance and series resistance of the generator are 500 V, 25Ω ; 0.08Ω and 0.045Ω , respectively. The generated emf is

- a. 505 V
 b. 502.5 V
 c. 497.5 V
 d. 495 V

36. A 250 V DC shunt motor has armature resistance of 0.1Ω and shunt resistance of 10Ω . When connected to DC supply, it develops a back emf of 242 V at 1500 rpm. The armature current at the time of starting is

- a. 80 A
b. 250 A
c. 2500 A
d. 2525 A
37. A 220 V DC series motor running at 800 rpm takes a current of 20 A and develops a back emf of 200 V. The motor has armature resistance of 0.6Ω and series resistance of 0.4Ω . If motor has to run at 600 rpm with the same current of 20 A, the external resistance to be connected in series with the armature is
- a. 2.5Ω
b. 2Ω
c. 1.75Ω
d. 1.5Ω
38. An induction motor operating at 0.8 pf lagging is consuming 300 kW. A zero real power consuming synchronous motor is connected across the induction motor to raise the pf to 0.92 lagging. The reactive power drawn by the synchronous motor is
- a. -352 kVAR
b. -225 kVAR
c. -127.8 kVAR
d. -97.2 kVAR
39. An interconnector cable having a reactance of $j0.05$ pu links two generating stations G_1 and G_2 as shown in Fig. II.39 where $|V_1| = |V_2| = 1$ pu. The load demands at two buses are $S_{D1} = 15 + j5$ pu and $S_{D2} = 25 + j15$ pu. The total reactive power (in pu) at the generating station G_1 when $\delta = 15^\circ$ is

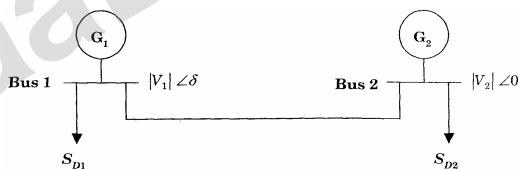

Fig. II.39

- a. 25.68
b. 25
c. 5.68
d. 5
40. A 10 MW generator is connected to load through a transmission line. If the incremental cost of production is $\frac{dF}{dP} = 0.1P + 3 \text{ Rs./MWhr}$ and loss in transmission line is 1 MW, the incremental cost of received power in Rs./MWhr is
- a. 5.44
- b. 5
c. 4.44
d. 4
41. An IDMT relay of rating 5A, 2.2s and having a relay setting of 125% is connected to a supply circuit through a CT having a ratio of 400/5. The plug setting multiplier of IDMT relay in the event of fault current of 4000 A will be
- a. 5
b. 8
c. 10
d. 125
42. A 2.5 kVA, 100/400 V single phase transformer has a leakage reactance of 0.06Ω , measured from the primary side. The leakage reactance (in pu) measured from the secondary side of the transformer is
- a. 0.96
b. 0.9
c. 0.015
d. 0.1
43. A single phase 50 Hz generator supplies an inductive load of 5000 kW by means of a 20 km long overhead transmission line whose total resistance and reactance are 0.39Ω and 3.96Ω , respectively. The receiving end voltage is required to be kept constant at 10 kV. The efficiency of transmission line when pf of load is improved to 0.9 lagging is
- a. 98.08%
b. 97.64%
c. 82.1%
d. 78.83%
44. Two generating stations G_1 and G_2 of ratings 10 MVA and 8 MVA respectively are linked by a line rated at 5 MVA, 0.1 Pu reactance. Each station has a reactance of 0.5 pu. If the base MVA is 10 MVA, short-circuit MVA of G_1 is
- a. 36.6
b. 34.28
c. 32.15
d. 10
45. If a bias voltage of V_T (in V) is applied to a forward-biased silicon p-n junction diode with a non-ideality coefficient of 2, the diode current (in A) shall be
- a. I_0

b. $(\sqrt{e}-1)I_0$

c. $\sqrt{e}I_0$

d. $(e-1)I_0$

46. Assuming the forward diode drop as 0V, the output voltage V_o , as shown in Fig. II.46, is

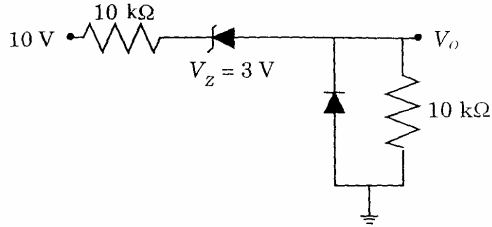

Fig. II.46

- a. 0 V
b. 5 V
c. 3.5 V
d. 6.5 V

47. Two two-port networks are connected in cascade. The combination is to be represented as a single two-port network. The parameters of the network are obtained by multiplying the individual

- a. z-parameter matrix
b. h-parameter matrix
c. y-parameter matrix
d. ABCD-parameter matrix

48. For the ideal OP-AMP shown in Fig. II.48, the output voltage V_o is

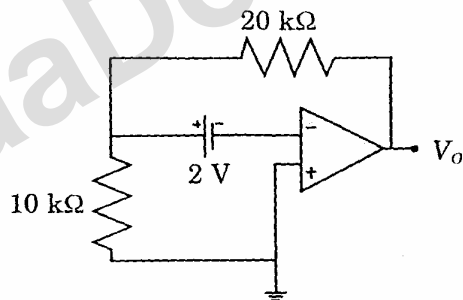

Fig. II.48

- a. 2 V
b. 6 V
c. 10 V
d. 20 V

49. How many minimum number of NOR gates are required to realize a two-input X-OR gate?

- a. 2
b. 3

c. 4

d. 5

50. The sequential circuit shown in Fig. II.50 will act as a

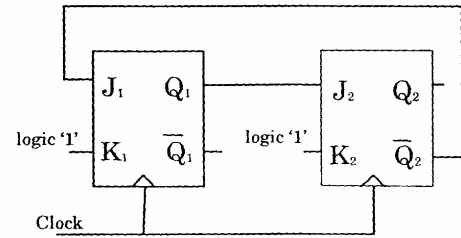

Fig. II.50

- a. Mod—1 counter
b. Mod—2 counter
c. Mod—3 counter
d. Mod—4 counter

SECTION - III

ALL QUESTIONS CARRY

1 MARK EACH

1. Chandrayaan-I, India's first mission to the moon, has 11 scientific instruments that are being released on the surface of the moon. These instruments are together known as
 - a. Moon Impact Probes
 - b. Terrain Mapping Cameras
 - c. Scientific Payloads
 - d. Spectrometers
2. The World Wide Web was invented by
 - a. Tim Berners-Lee
 - b. Narayanmurthy
 - c. Sabeer Bhatia
 - d. Charles Babbage
3. How many diagonals does a quadrilateral have?
 - a. one
 - b. two
 - c. four
 - d. eight
4. ISO 14000 standards deal with
 - a. quality management
 - b. production management
 - c. human resource management
 - d. environmental management
5. Which Indian politician's autobiography is titled *The Story of My Life*?
 - a. Morarji Desai
 - b. Mahatma Gandhi
 - c. Lal Krishna Advani
 - d. Atal Behari Vajpayee
6. The phrase 'through thick and thin' means
 - a. big and small
 - b. thin and fat
 - c. large object
 - d. under all conditions
7. Picturesque means
 - a. photogenic
 - b. simple
 - c. stimulating
 - d. ugly
8. Diligent means
 - a. intelligent
 - b. energetic
 - c. modest
 - d. industrious
9. The opposite of miserly is
 - a. spendthrift
 - b. generous
 - c. liberal
 - d. charitable
10. The opposite of ingratitude is
 - a. sympathy
 - b. reward
 - c. thankfulness
 - d. stimulation
11. The appropriate missing word in the blank space in the sentence "I prefer coffee _____ tea." is
 - a. than
 - b. over
 - c. for
 - d. to
12. The appropriate missing word in the blank space in the sentence "Many relatives attended _____ him during his illness." is
 - a. of
 - b. on
 - c. for
 - d. with
13. The article required before the word "one-eyed" in the sentence "There was _____ one-eyed beggar by the multiplex." is
 - a. the
 - b. a
 - c. an
 - d. nil
14. The article required before the word University in the sentence "She met Professor Shah at _____ University." is
 - a. a
 - b. an
 - c. the
 - d. nil
15. Which one is the correct sentence amongst the following sentences?

- a. Mr. Gupta, accompanied by his friends, were assembled on the lawns.
 - b. Mr. Gupta, accompanied by his friends, are assembled on the lawns.
 - c. Mr. Gupta, accompanied by his friends, assembled on the lawns.
 - d. Mr. Gupta, accompanied by his friends, have assembled on the lawns.
16. Who was the first woman to be elected as the President of the Indian National Congress?
- a. Sarojini Naidu
 - b. Sonia Gandhi
 - c. Indira Gandhi
 - d. Annie Besant
17. Which political leader delivered the famous 'I have a dream' speech?
- a. Jawaharlal Nehru
 - b. Winston Churchill
 - c. Martin Luther King
 - d. Rabindranath Tagore
18. Who established the organization 'Khudai Khidmatgar'?
- a. Hyder Ali
 - b. Gopal Krishna Gokhale
 - c. Maulana Abul Kalam Azad
 - d. Khan Abdul Ghaffar Khan
19. Analgesics are drugs used to prevent or relieve
- a. aches and pain
 - b. fever and high body temperature
 - c. hormone deficiency
 - d. stress and anxiety
20. The abbreviation CD stands for
- a. Circular Disc
 - b. Computer Device
 - c. Compact Disc
 - d. Code-Demodulator

FaaDoOEngineers.com