

Name :

Roll No. :

Invigilator's Signature :

CS/B.Tech(ECE,EE,EEE,IC,BME,PWE,CSE,IT)/SEM-3/EE-301/2009-10

2009

CIRCUIT THEORY & NETWORKS

Time Allotted : 3 Hours

Full Marks : 70

The figures in the margin indicate full marks.

*Candidates are required to give their answers in their own words
as far as practicable.*

GROUP - A

(Multiple Choice Type Questions)

1. Choose the correct alternatives for any ten of the following :

10 × 1 = 10

- i) Laplace transform analysis gives
 - a) time domain response only
 - b) frequency domain response only
 - c) both (a) & (b)
 - d) real response only.
- ii) If a function is shifted by 'T', then it is correctly represented as
 - a) $f(t - T) u(t)$
 - b) $f(t - T) u(t - T)$
 - c) $f(t) u(t - T)$
 - d) $(t - T)f(t - T)$.

iii) The equivalent resistance between x & y of the figure shown below is

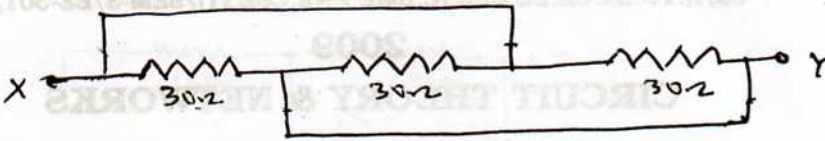

- a) 30Ω
 - b) 50Ω
 - c) 60Ω
 - d) 10Ω.
- iv) If $f(t)$ is an even function, then its Fourier transform $F(j\omega)$ is given by

a) $2 \int_0^{\infty} f(t) \cos \omega t dt$

b) $\int_0^{\infty} f(t) \cos \omega t dt$

c) $2 \int_0^{\infty} f(t) \sin \omega t dt$

d) $\int_0^{\infty} f(t) \sin \omega t dt.$

v) The Thevenin's equivalent resistance of the given circuit with respect to the terminals A & B is equal to

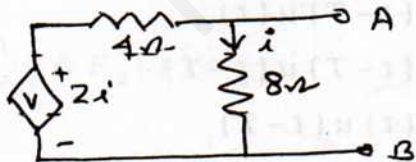

- a) 2.66Ω
- b) 3.2Ω
- c) 8Ω
- d) 12Ω.

vi) The value of the unity impulse function $\delta(t)$ at $t = 0$ is

- a) 0 b) ∞
c) 1 d) indeterminate.

vii) The number of links for a graph having 'n' nodes & 'b' branches are

- a) $b - n + 1$ b) $n - b + 1$
c) $b + n - 1$ d) $b + n$.

viii) The h parameters h_{11} & h_{12} are obtained by

- a) shorting output terminals
b) opening input terminals
c) shorting input terminals
d) opening output terminals.

ix) The convolution of $f(t) * g(t)$ is

- a) $\int_0^{\infty} f(t) g(t - \tau) dt$
b) $\int_0^t f(\tau) g(t - \tau) d\tau$
c) $\int_0^t f(t - \tau) g(\tau) dt$
d) $\int_0^t f(t) g(t - \tau) dt.$

- x) A ramp voltage $V(t) = 100t$ is applied to an RC series circuit with $R = 5 \text{ k}\Omega$ & $C = 4 \mu\text{F}$. The maximum output voltage across capacitor is
- a) 0.2 volt b) 2.0 volt
 c) 10.0 volt d) 50.0 volt.
- xi) The voltage across the dependent source of the circuit shown is

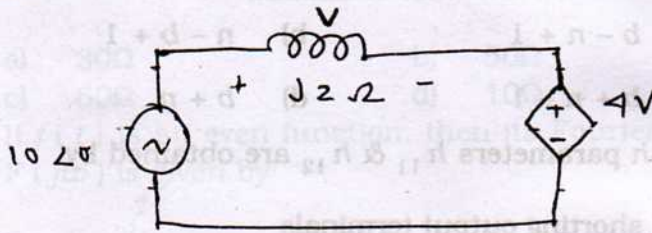

- a) $8 \angle 0^\circ$ b) $4 \angle 0^\circ$
 c) $4 \angle 90^\circ$ d) $8 \angle -90^\circ$.
- xii) Relative to a given fixed tree of a network
- a) link currents form an independent set
 b) branch currents form an independent set
 c) branch voltages form an independent set
 d) both (a) & (c).

GROUP - B

(Short Answer Type Questions)

Answer any *three* of the following. $3 \times 5 = 15$

2. In the circuit shown, determine the current $i(t)$ when the switch is changed from position 1 to 2. The switch is moved from position 1 to 2 at time $t = 0$.

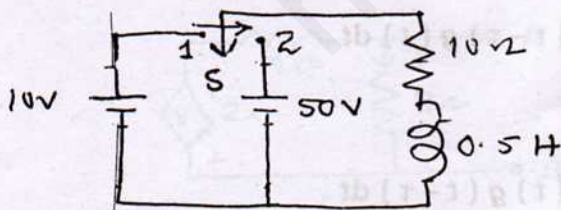

3. For the circuit shown in the figure, find the current in the 2Ω resistor by using Thevenin's theorem.

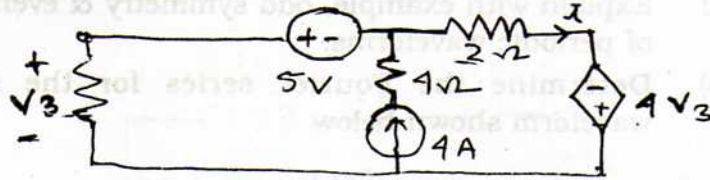

4. Draw the graph corresponding to the given incidence matrix :

$$A = \begin{bmatrix} -1 & 0 & 0 & 0 & +1 & 0 & +1 & 0 \\ 0 & -1 & 0 & 0 & 0 & 0 & -1 & +1 \\ 0 & 0 & -1 & -1 & 0 & -1 & 0 & -1 \\ 0 & 0 & 0 & 0 & -1 & +1 & 0 & 0 \\ -1 & +1 & +1 & +1 & 0 & 0 & 0 & 0 \end{bmatrix}$$

5. Determine the cut off frequency for the high pass filter shown below.

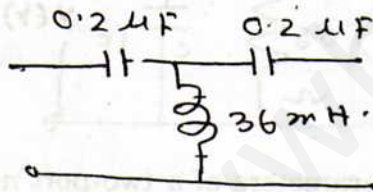

6. Find the Z-parameters of the network given below :

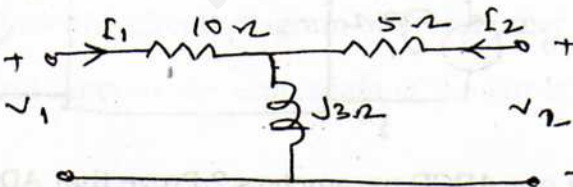

GROUP - C

(Long Answer Type Questions)

Answer any *three* of the following. $3 \times 15 = 45$

7. a) Explain with example, odd symmetry & even symmetry of periodic waveforms.
 b) Determine the Fourier series for the saw tooth waveform shown below

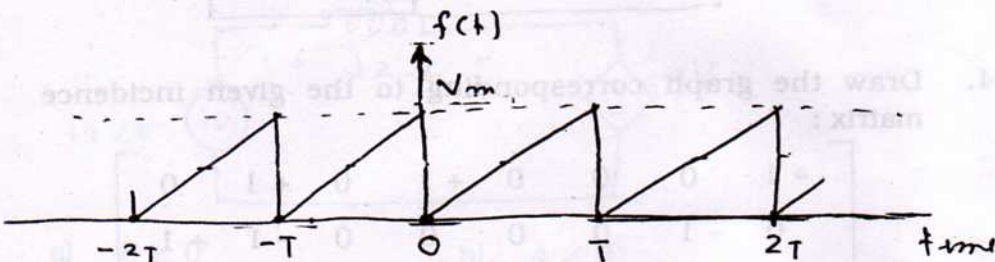

- c) Applying Fourier transforms determine the output voltage across the capacitor if the excitation is a current source of $i(t) = e^{-t} u(t)$.

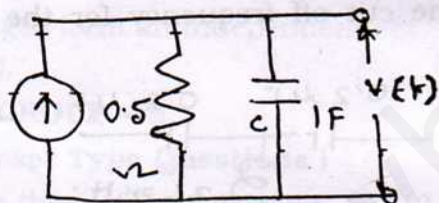

3+7+5

8. a) The hybrid parameters of a two-port network shown in figure are $h_{11} = 1 \text{ k}\Omega$, $h_{12} = 0.003$, $h_{21} = 100$, $h_{22} = 50 \mu\text{S}$. Find V_2 & Z parameters of the network.

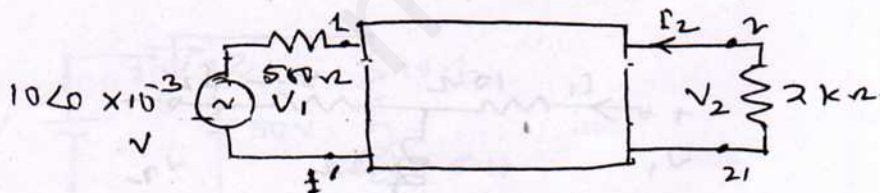

- b) What are ABCD parameters? Prove that $AD - BC = 1$.

10 + 5

9. a) For the circuit shown, determine the load current I_2 using Norton's theorem.

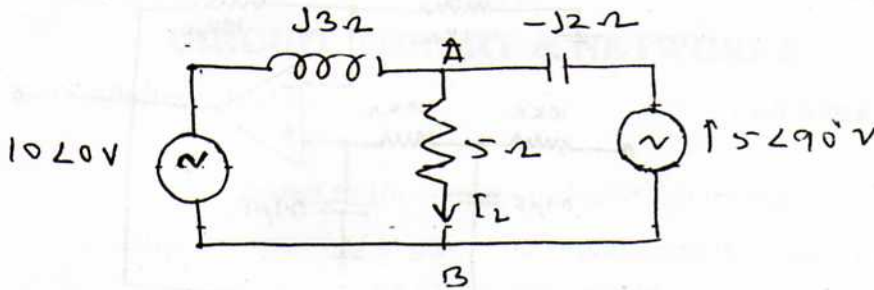

- b) Convert the active network shown in figure to a single voltage source in series with impedance.

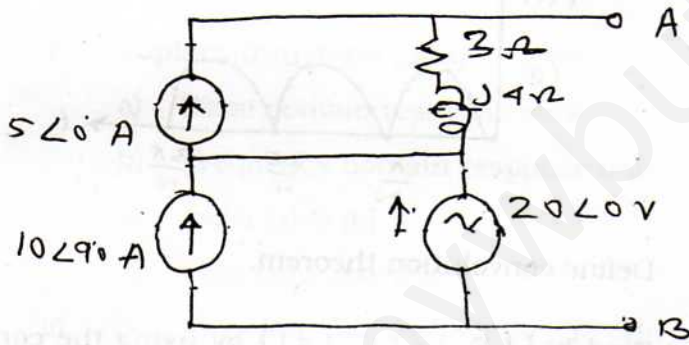

7 + 8

10. a) Draw the circuit diagram of a first order high pass filter and find out the expression of the cut-off frequency. 5
- b) Draw and explain the characteristics of ideal band-pass & band-stop filter. 5

- c) The circuit shown in figure is a second order low-pass filter. Analyze the circuit and find out the cut-off frequency. 5

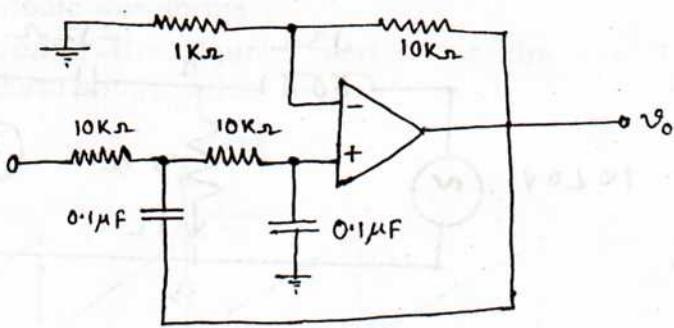

11. a) Find the Laplace transform of the periodic waveform shown in figure.

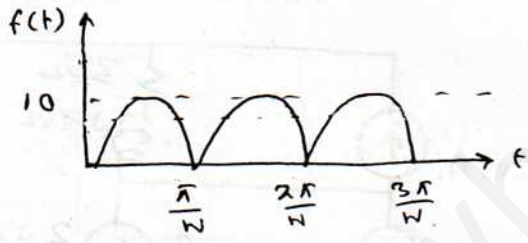

- b) Define convolution theorem.
 c) Find $h^{-1} \{ F_1(s) F_2(s) \}$ by using the convolution of the following functions :

$$F_1(s) = \frac{1}{s+1} \text{ \& } F_2(s) = \frac{1}{s+2} \quad 8 + 2 + 5$$