



**KIIT UNIVERSITY**

Declared U/S 3 of UGC Act, 1956  
Bhubaneswar, Odisha, India

# PROSPECTUS

SESSION: 2014-2015



## BE FOCUSED

Kalinga Institute of Industrial Technology

*Continuous Learning ...*



# BE FOCUSED

*Continuous Learning ...*

Kalinga Institute of Industrial Technology

[www.kiit.ac.in](http://www.kiit.ac.in)

# Index

Intellectual Capital	1
Schools of KIIT University	3
School of Civil Engineering	5
School of Mechanical Engineering	6
School of Electrical Engineering	7
School of Electronics Engineering	8
School of Computer Engineering	9
School of Computer Application	10
School of Architecture & Planning	11
Kalinga Institute of Medical Sciences	12
Kalinga Institute of Dental Sciences	15
Kalinga Institute of Nursing Sciences	17
School of Biotechnology	18
KIIT School of Law	19
School of Management	20
School of Rural Management	21
School of Film & Media Sciences	22
School of Fashion Technology	23
School of Fine Art	24
Centres of Excellence	25
International Programme	27
Class Room, Library	28
Placement	29
Scholarship	32
Fees Structure	33
Registration & Examination Fees	34
Ph.D/PDF Programme	35
Hostel	39
Facilities	40
Student Activity	43

# Index



*Declared U/S 3 of UGC Act, 1956*

Accredited by NAAC  
of UGC in 'A' Grade  
(Highest CGPA among self-  
financing universities)  
Accredited by NBA of AICTE  
Approved by Statutory  
Bodies of Govt. of India

## Global Recognition

In order to make its presence felt in the global education scenario, KIIT University has obtained membership of various prestigious world bodies, accreditation boards and associations. Each of these bodies have large number of member Universities and members benefit from exchange, degree equivalence, fellowship and research grants in furthering the cause of higher education amongst themselves.

KIIT University is a member of prestigious national and international organizations such as

- International Association of Universities (IAU)
- Association of Indian Universities (AIU)
- Association of Commonwealth Universities (ACU)
- University Mobility of Asia and the Pacific (UMAP)
- International Association of University Presidents (IAUP)
- Association of Universities of Asia and the Pacific (AUAP)
- International Institute of Education (IIE), New York
- United Nations Academic Impact (UNAI)
- Eurasian Silk Road Universities Consortium (ESRUS)

## Vision of KIIT

To create an advanced centre of professional learning of International standard where pursuit of knowledge and excellence shall reign supreme, unfettered by the barriers of nationality, language, cultural plurality and religion.



## Mission of KIIT

- Imparting quality technical education of international standard and imbuing skill for solving real life problems
- Inculcating global perspective in attitude
- Creating leadership qualities with futuristic vision.
- Fostering spirit of entrepreneurship and realization of societal responsibilities
- Cultivating adaptation of ethics, morality and healthy practices in professional life.
- Instilling habit of continual learning.
- Encouraging and supporting creative abilities and research temperament
- Establishing and promoting close interaction with industries and other utility sectors and keep abreast with state of the art technology.

Dr. Achyuta Samanta,  
Founder, KIIT & KISS



# Founder's Message

A warm welcome to KIIT University!

Beginning its journey as a modest industrial training institute, KIIT University has grown into the most happening multidisciplinary university of the country within a short time of two decades. It not only offers a world-class learning experience that is rooted in a rich educational culture of excellence, but also stands at an enviable position where quality education has been synergized with social values. Today KIIT University is one of the most sought after institutions of professional education, offering about 100 academic programmes and having more than 20,000 students from all corners of India and around 22 countries.

Students graduating from KIIT University are not only equipped with cutting edge skills necessary for success in present day global workplace, but also imbibed with social values and concern. The University's cosmopolitan campus offers world-class academic, residential and cocurricular facilities for the students. Students greatly benefit from multidisciplinary and multicultural ambience of the University. Given all these, it is not surprising that KIIT University has been achieving cent percent campus placements since its inception. The University uniquely places equal emphasis on academic placement and in recent years an increasing number of students have been finding notable success in top institutions of India and abroad for higher studies.

I welcome you once again to this temple of learning.

## About the Founder

A strong man in a small frame, Achyuta Samanta by his dedication and determination has dwarfed everyone around him. Despite being born poor, he has created the great educational conglomerate through his sheer will power and passion to create a world sans poverty and ignorance. While KIIT University depicts one side of his persona, its protégé, Kalinga Institute of Social Sciences (KISS), a home for 20,000 poorest of the poor Tribal Children, has been his most wonderful creation. He has been a member of several National and International Bodies. Some of these are as follows:

### Member - National Bodies

- Commission Member-** University Grants Commission (UGC)
- Member-** National Council for Teacher Education, Ministry of HRD, Govt. of India
- Member -** Ministry of Human Resource and Development, Govt. of India (Committee on 'Round Table' on Disadvantaged Section, Women and SC/ST for expansion of educational opportunities).
- Member -** National Executive Council, ISTE, Govt. of India
- Member -** Academic Council of Assam Central University, Silchar (President of India Nominee)
- Member -** Academic Council, Central University, Odisha (Nominee of the MHRD, Govt. of India)

### Member - International Bodies

- Board Member -** Asia Economic Forum (AEF)
- Member -** International Institute of Education (IIE), New York
- Member -** University Mobility of Asia and the Pacific (UMAP), Bangkok
- Member -** Association of Universities of Asia and the Pacific (AUAP)
- Member -** International Association of University Presidents (IAUP), U.K.
- Member -** Asia-Pacific Academic Consortium for Public Health (APACPH)

# Chancellor's Profile



Prof. N. L. Mitra received his M.Com, LL.M. and Ph.D. from Calcutta University. He holds certificate in Human Rights from International Institute of Human Rights, Strasbourg, France. Prof. Mitra has been formerly the Vice-Chancellor of National Law School of India University (NLSIU), Bangalore (1997-2001) and National Law University (NLU), Jodhpur (2001-2004). He has been the Chairman of several important Government of India Committees and has advised Reserve Bank of India and other important bodies. He is also member of NLIUO's Governing Council and Executive Council and thus supervises all their academic and administrative activities. He is a life member of Indian Institute of Public Administration (IIPA), Member of India Law Institute (ILI), former member of the Executive Committee of Commonwealth Legal Education Association (CLEA) and Member of the Legal Education Committee of Bar Council of India (BCI).

## Prof. N. L. Mitra

Chancellor, KIIT University

- ❑ Member of Legal Advisory Committee- SEBI
- ❑ Member of the Patent and Copyright law Reforms Committees under Ministry of Commerce and Ministry of HRD respectively
- ❑ Member of the Banking Law Reform Committee in 1999- 2000
- ❑ Member of the curriculum development committee of the American Bar Council
- ❑ Member of the Bar Council of India
- ❑ Chairman of Legal Education of the Bar Council of India
- ❑ Advisor to the Governor of Reserve bank financial sector reforms
- ❑ Advised the Ministry of Agriculture on Agricultural Marketing Model Act
- ❑ Advised Ministry of Finance, Ministry of Corporate Affairs, ministry of Commerce and Industries Ministry of Women and Child Welfare and Ministry of Environment
- ❑ Headed the Committee to Bankruptcy and Financial Fraud
- ❑ Headed the civil action group of post Earthquake Committee in Ahmedabad
- ❑ Head a committee constituted regarding farmer suicide in Karnataka
- ❑ Headed many UGC Committees as one of the senior most Vice-Chancellor
- ❑ Piloted the World Bank environment project for India during 1998-2000
- ❑ Developed the present education policy of Bar Council of Indian including its regulations
- ❑ Drafted many of the SEBI regulations
- ❑ Head a One man committee for legal reform on security exchange board of India
- ❑ Participated in the drafting of bills on Information Technology
- ❑ Advisor, IIT Kharagpur, RGSOIPL
- ❑ Guest Faculty of some Foreign Universities.

*Professor Mitra has authored a number of projects, and monographs, including some for the Union Ministry of Commerce, New Delhi.*

# Vice Chancellor's Message



**Prof. P. P. Mathur**  
Vice Chancellor, KIIT University

Welcome to the KIIT University. As you consider where to go for higher education I invite you to discover for yourself the multidimensional and transformative educational experience that KIIT University provides. KIIT University is renowned for teaching excellence and setting exemplary engagement with the societal needs. The University provides an environment that allows the students to realize their potential in full and to develop their individuality and skills through an education that is backed by cutting edge research. Our goal is to arm the students with an extraordinary sense of humanity and a creative intellect, thereby equipping them with the ability to work independently and intellectually.

Ours is a nascent but a very vibrant University. We are celebrating our 10th Foundation Day in February 2014. I am extremely happy to make it known to you that in such a short span of time the University has got a very high visibility both nationally and internationally. The University simply sparkles with freshness, energy and charm of its generous Founder Dr. Achyuta Samanta who has distinguished himself as a great social worker and philanthropist dedicated to the cause of education. The University campuses have environment friendly state-of-art buildings that are attractive to students, faculty and visitors alike. The University has highly diverse student community with the presence of foreign students which provides an international flavour and diverse culture. The University provides a unique environment in which students can develop their strengths through reflection and discussions.

The entire campus is connected with high speed wi-fi enabled connection which is so vital for sustenance of academic activity. The University has large library collections and electronic resources. There are at least five important reasons why you should opt to study at KIIT University. Firstly, you will have a great learning experience and all the qualified graduates have jobs before they leave the campus, unless they choose, for a specific reason, not to enter formal employment. Secondly, latest teaching methods and practical exposure is provided to the students through periodically updated curricula. Thirdly, we are well networked with the industry and have developed strategic partnerships with the top national and multinational companies. Fourthly, we prepare leaders for the future. You will be able to acquire an education that extends beyond the curriculum and you will have ample opportunity to have your leadership and professional skills through social engagement and co-curricular activities. We have excellent sports facilities and a large number of cultural, scientific and technology student clubs. Finally we prepare our graduates for facing challenges of the globalized world by inculcating right attitude in them and developing good communication skills.

I hope that the Prospectus gives you all the information you need to make KIIT University as your choice University. It has been designed to familiarize you with all the aspects of the University.

The commitment of KIIT University to the prosperity of humanity and society will continue, through bold, cooperative initiatives with local communities and expanded activities within the country and abroad. The University values and is committed to working harder and making further strides in research and making its mark in global scenario.

I invite you to be a part of KIIT University where you will not only find the learning experience enjoyable and rewarding but you would also grow as an excellent professional who have both insights into specialized knowledge as well as strong leadership abilities to become a leader of the 21 century.

# KIIT UNIVERSITY

The journey of KIIT University from a modest technical training centre way back in 1992 to one of the most happening multidisciplinary universities has been both fascinating and challenging. Started with just Rs.5000 (US \$100) by Dr. Achyuta Samanta, it is now widely recognized as the fastest growing, well branded and vibrant institute in India with positive accessibilities in all sectors of academic endeavours. It also stands at an enviable position where quality of education has been synergized with social values. Spread over an area of 25 sq. km. with nearly 20,500 students from all corners of India and around 22 countries, KIIT University is accredited by NAAC of UGC in 'A Grade' (highest CGPA among self-financing universities) and NBA of AICTE.

KIIT has a strong international presence with more than 600 foreign students and membership with international bodies, including International Association of Universities (IAU), Association of Indian Universities (AIU), Association of Commonwealth Universities (ACU), University Mobility in Asia and the Pacific (UMAP), International Association of University Presidents (IAUP), Association of University of Asia Pacific (AUAP), Institute of International Education (IIE), New York, Eurasian Silk Road Universities Consortium (ESRUC) and United Nations Academic Impact (UNAI). It has academic partnership with more than 80 world-class universities. The University supports academic research environment and has set up a Centralized Advanced Research Centre spread over 1,50,000 sq. ft. built-up area with sophisticated equipments for advanced research.

As one of the most vibrant universities of the country, KIIT University has been organizing academic deliberations of national and international signification regularly. It has the unique distinction of handling 18,000 delegates during the 99<sup>th</sup> Indian Science Congress (2012) which was inaugurated by the Prime Minister of the country in the presence of important Cabinet Ministers and distinguished academicians. It also has the distinction of having the 2012 Inter-Congress of International Union of Anthropological and Ethnological Sciences (IUAES) and the 92 Indian Economic Association Conference (2009).





## AN ILLUSTRIOUS HISTORY

KIIT's unique focus on quality education with humane touch transformed it from a small technical institute to a world-class university within the shortest span of time. The growth of KIIT as a world-class university spread over 25 sq. km. of land in 20 lush green sprawling campuses in a built-up area of 1,00,00,000 square ft. is incredible indeed. KIIT Society had a modest beginning in 1992 with a vocational training centre. KIIT took shape as an institute in 1997 when B.Tech., MCA and MBA courses were started. It was declared a University (u/s 3 of UGC Act of 1956) in 2004, within only six years of commencement of Degree programmes. Taking its growth to the next level, dedicated schools to offer Bachelor and/or Master Degree programmes in various disciplines were set up periodically. At present, KIIT has 28 schools offering more than 100 academic programmes, with an independent campus for each stream of education.



**KIIT has a teacher-  
student ratio of 1: 12  
& has partnerships  
with 80 world-class  
Institutions**

## **INTELLECTUAL CAPITAL**

More than 1500 academic and research staff – many leaders in their fields, with international reputations – provide stimulating learning environment and excellent standards of teaching. Even though it is a self-financing institution, KIIT is a well structured and decentralized organization. It is perhaps the only self-financing institution in the country where top functionaries, including Chancellor and Vice Chancellor, are renowned academicians. The quality is amply demonstrated by the patents held by various faculty members, the research grants coming from various agencies both in India and abroad, national and international conferences, symposiums and workshops held here and the hundred percent placement records.

Faculty members of the University actively involve themselves in consultancy projects from various industries. During 2012 – 13 more than 37 research projects from various national and international funding agencies have been sanctioned with a total budget outlay of over Rs. 13 crore, and 22 consultancy projects to the tune of Rs. 19 crore. KIIT actively promotes students research and projects of its students have the distinction of being appreciated at national and international forum, including being selected for the prestigious Indian Science Congress.

## KNOWLEDGE ALLIANCE

KIIT University has established academic partnership and collaboration with more than 80 world class universities from across the world. The partnerships provide for students, faculty & research scholar exchange programme, internship for UG/PG course, research and development participation, short-term courses for faculty & students, short-term occupational training, exchange of publications & information and seminars and conferences. As a direct benefit, KIIT students have been going to various partner universities regularly.

KIIT University has also been receiving exchange students from partner universities. Recently, 235 students from Afghanistan completed bridge courses in the University and a group of 40 students from Ataturk University, Turkey completed six month course in English. Students from the University of Lausanne, UC-Davis, and London School of Hygiene visited School of Biotechnology for three months each for their thesis projects.

Confident &  
determined on  
the journey to excellence

100 + Academic Programmes 20,500 Students & 1500 Faculty

# Schools of KIIT UNIVERSITY

School of Civil Engineering

School of Computer Engineering

School of Electrical Engineering

School of Electronics Engineering

School of Mechanical Engineering

School of Computer Application

School of Architecture & Planning

School of Applied Sciences

School of Law

School of Management

School of Rural Management



School of Biotechnology

Kalinga Institute of Medical Sciences

Kalinga Institute of Dental Sciences

Kalinga Institute of Nursing Sciences

School of Fashion Technology

School of Film & Media Sciences

School of Fine Art

School of Language

School of Yoga

School of Sports

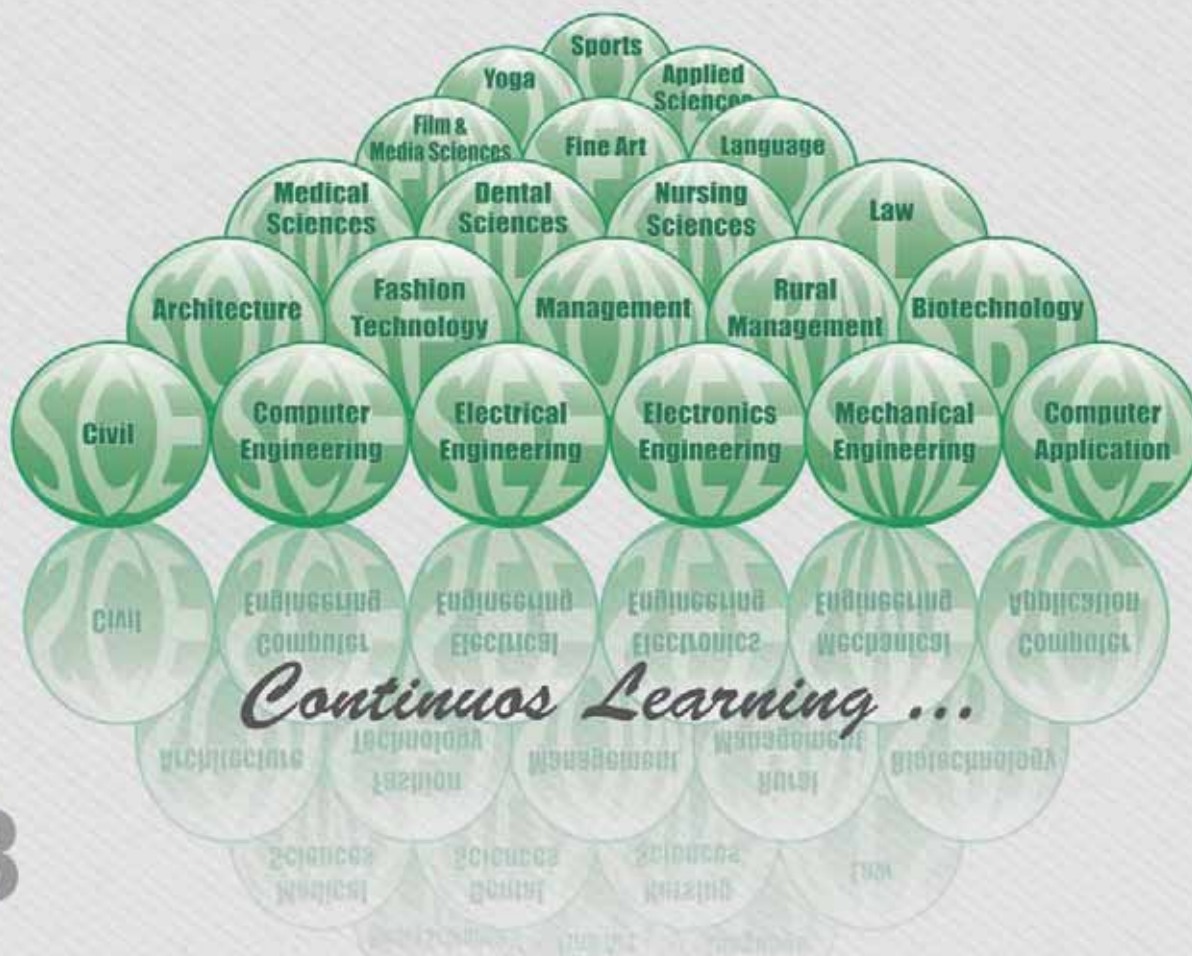



# KIIT Green



**KIIT Green** is a bold initiative of KIIT University to control environmental pollution and to create a healthy ambience in and around 25 sq. km. area in which different campuses of KIIT are located. A mega plantation has been done in which more than one lakh saplings were planted. The University has drawn ambitious plan to make KIIT campus totally vehicle free. In the first phase, use of two wheelers, both by students and staffs, has been prohibited, after putting in place an effective alternative transport arrangement. Besides mass plantation and limiting vehicular pollution, other environmentally friendly initiatives under KIIT Green are rain water harvesting and water management, sewerage treatment, biogas, solar energy, etc.





# School of Civil Engineering

School of Civil Engineering aims to meet the future needs of the construction industry and society by producing professional civil engineers competent in analyzing, designing and managing solutions for practical engineering problems. It imparts sound fundamentals at B.Tech. level, specialized subjects at M.Tech. level and high quality research guidance at Ph.D. level. Teaching learning process is seamlessly supported by excellent academic support facilities (laboratory, library, etc.). Library and reading room is available to students and staff, round the clock. The School is actively engaged in project and consultancy activities and disseminates research and project achievements through various publications. It has established collaborations in the areas of regular academic, research and consultancy activities with various organizations.

The School has been able to build an effective Institute-Industry interaction and lays focus on entrepreneurship development amongst the students.

Major areas of focus are on resources planning, GIS application, performance analysis of flexible pavement, design of foundations, deep excavation schemes, ground improvement solutions, industrial waste utilization, alternative building material, ground water pollution, seismic resistant design of structures, designing of water reuse system, development of energy efficient aeration system and so on. The School has recently undertaken consultancy projects on Integrated Water Resources Management sponsored by Asian Development Bank (ADB), Manila, Cement and concrete performance test, soil testing sponsored by Unisol Inc, ESSAR Construction and Shapoorji Pallonji respectively.

## Academic Programme

Bachelor of Technology (B. Tech) in Civil Engineering 4 Years

Master of Technology (M. Tech) in Civil Engineering  
(Construction Engineering & Management) 2 Years

Master of Technology (M. Tech) in Civil Engineering  
(Structural Engineering) 2 Years

### Dual Degree Programme

B.Tech & M.Tech - Dual Degree 5 Years

B.Tech & MBA - Dual Degree 5 Years

Ph.D

PDF

## Laboratory

**Geotech Engg. Lab**

**Environmental Engg. Lab**

**Survey Lab**

**Transportation Engg. Lab**

**Concrete Lab**

**Hydraulics Lab**

**Heavy Structural Engg. Lab**

**Computer Centre**

**Modeling & Simulation Lab**

**Material Testing Lab**



# School of Mechanical Engineering

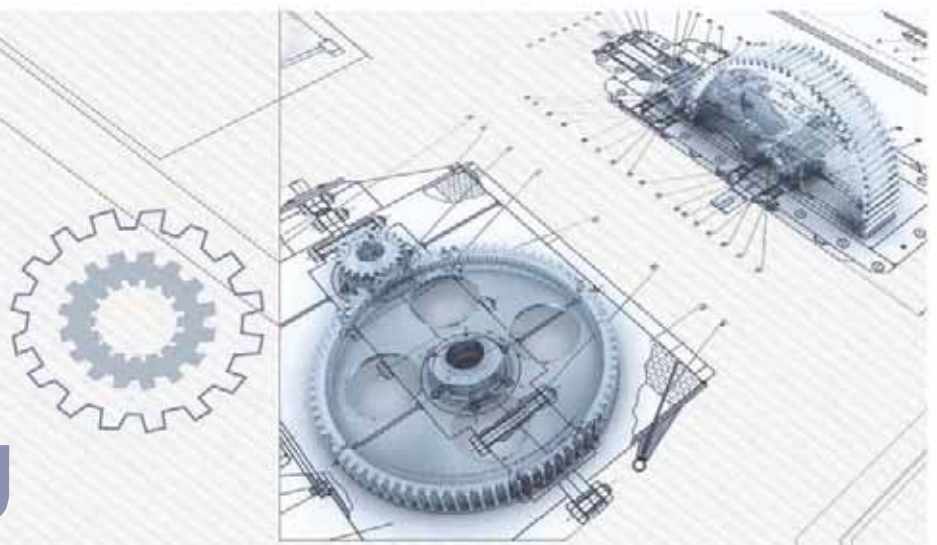

School of Mechanical Engineering produces graduates who can meet the rapidly changing needs of industry which demand new skills. It has an ambience and specialized laboratories for Research and Development. Even undergraduate students get opportunity to involve themselves in high-end research work to build skills beyond curriculum. In addition to classes, the School organises regular Visiting Lectures delivered by Industry Experts and arranges industrial visits for both faculty and students. As a placement support, it offers certificate courses to students during summer vacation in the areas of Quality Engineering and Management (TQM, TPM, Six Sigma, Optimization Techniques, FMCA/FMECA, Maintainability issues) and Mechatronic (Hydraulic / Pneumatic circuit design, Process Control Technology) and latest Softwares that suit Mechanical Engineering. Both the postgraduate and PhD scholars are engaged in high end research activities and publication processes. The School is also actively engaged in organizing international and national level conferences. The B.Tech. students are actively participating in different international level competitions through various live projects. The school possesses highly qualified and very reputed faculty members from various IITs, NITs and Universities.

Current consultancy and research & development areas of the School include Impingement Heat Transfer, Combustion Engineering, CFD, Thermal Systems Design and Optimization, Control Technology, Artificial Intelligence, Biomass and Biofuels, Composite Materials, Residual Stresses in Fusion Welded Structure, surface finish optimization and CAD modelling. Material processing technology, cleaner manufacturing technology, automotive engineering, quality engineering and management and Industrial Tribology are the other areas of interest. Research and development efforts of the School are supported by bodies like AICTE, DST, MNRE, TATA Co. and IE, Govt. of India.

## Academic Programme

Bachelor of Technology (B. Tech) in Mechanical Engineering	4 Years
Bachelor of Technology (B. Tech) in Mechanical Engineering (Automobile)	4 Years
Master of Technology (M. Tech) in Mechanical Engineering (Manufacturing Process & System)	2 Years
Master of Technology (M. Tech) in Mechanical Engineering (Thermal Engineering)	2 Years

## Dual Degree Programme

B.Tech & M.Tech - Dual Degree	5 Years
B.Tech & MBA - Dual Degree	5 Years
Ph.D	
PDF	



## Laboratory

Applied Mechanics Lab  
Heat Power Lab  
Heat Transfer Lab  
Material Testing Lab  
Central Workshop  
FMS & Robotics Lab  
Metal Cutting Lab  
Meteorology & Instrumentation Lab  
Fluid Mechanics Lab  
Hydraulic Machines Lab  
Refrigeration Lab  
Computer Assisted Design Lab  
Vibration Lab  
Refrigeration & AC Lab  
Computer Integrated Manufacturing Lab.  
Simulation Lab.



# School of Electrical Engineering

The academic objective of the School of Electrical Engineering is to produce high caliber Electrical Engineers capable of making immediate contribution to industry and take responsibility of the development, design, construction, application and operation of devices and systems. The School takes pride in the fact that its alumni are placed in responsible positions with various central and state government bodies, PSUs in India, and in the private sector both within the country and outside. The School has also been instrumental in producing highly qualified engineering teachers and researchers through its Masters and Doctoral programmes. The success of the B. Tech. programme can be gauged from the fact that a large number of the graduating students have been placed in core sector companies in addition to those in the IT and ITeS sector. Several of the School's alumni are now pursuing post graduate or doctoral studies in US universities.

Broad areas of research include power system economic operation, optimal load flow, flexible AC transmission system, HVDC transmission, vector control of AC drives, power quality, selective harmonic elimination and non conventional energy sources. Recently, the school has bagged a consultancy project from Reliance Energy on consumer indexing at power distribution level in Jajpur Road (Odisha).

## Academic Programme

Bachelor of Technology (B. Tech) in Electrical Engineering	4 years
Master of Technology (M. Tech) in Electrical Engineering (Power Electronics & Drives)	2 years
Master of Technology (M. Tech) in Electrical Engineering (Power Energy System)	2 years

### Dual Degree Programme

B.Tech & M.Tech - Dual Degree	5 Years
B.Tech & MBA - Dual Degree	5 Years

Ph.D

PDF

## Laboratory

Electrical Science Lab  
Elect. M/c Lab  
Computational Method Lab  
Control System Lab  
Power System Lab  
Programming Logic control lab  
Power Electronics Lab  
Drives Lab  
Energy System Lab  
Modeling & Simulation Lab  
Circuit Lab  
Measurement lab  
Project Lab  
R&D Lab





# School of Electronics Engineering



School of Electronics Engineering aims to produce Electronics Engineering professionals to lead a successful career in industry, pursue higher studies or entrepreneurial endeavors. Graduates of the school are versatile, adaptable and possess analytical capacity to offer techno-commercially feasible and social acceptable solution to real life engineering problems in the field of Electronics & Telecommunication, Electronics & Electrical and Electronics & Instrumentation. The school has been involved in teaching and research in diverse aspects of Telecommunications, Microelectronics and VLSI, Signal Processing, RF and Microwave, Instrumentation Engineering. The classroom studies are reinforced by well equipped laboratories for the students to nature their ability to handle real life problem. The programs in the school are supported by updated curriculum to keep pace with rapidly changing technology. The school, which has a qualified and experienced team of faculty members, conducts regular workshops, conference, seminars and invited talks.

The school is actively engaged in R&D activities and in course of time, projects have been sponsored by Department of Atomic Energy, Defense Department, DST and AICTE etc. Some of the recent sponsored projects undertaken by the school are in the area of solar energy photovoltaic and RF and Microwave Engineering.

## Academic Programme

Bachelor of Technology (B. Tech) in Electronics and Telecommunication Engineering	4 Years
Bachelor of Technology (B. Tech) in Electronics & Electrical Engineering	4 Years
Bachelor of Technology (B.Tech) in Electronics and Instrumentation Engineering	4 Years
Master of Technology (M. Tech) in Electronics & Telecommunications Engineering (Communication Engineering)	2 Years
Master of Technology (M. Tech) in Electronics & Telecommunications Engineering (VLSI & Embedded System)	2 Years
Master of Technology (M. Tech) in Electronics & Telecommunications Engineering (RF & Microwave)	2 Years

### Dual Degree Programme

B.Tech & M.Tech - Dual Degree	5 Years
B.Tech & MBA - Dual Degree	5 Years
Ph.D	
PDF	



## Laboratory

Basic Electronics Lab.  
Analog Electronics Lab  
Digital Electronics Lab  
Microprocessor Lab  
Communication Lab  
Advanced Communication Lab  
Microwave Lab  
Embedded System Lab  
VLSI Lab  
DSP Lab  
OOPS Lab  
Control and Instrumentation Lab  
Wireless and Communication Networking Lab

### Research Lab

Thin Film Photovoltaic Lab:  
DC/RF Sputtering System  
Vacuum Coating Unit  
High Speed Ball Mill (Fritsch, Germany)  
Keithley Source Measure Unit  
Solar Simulator - SS150 (Scientech, Canada)  
UV-VIS Spectrophotometer (Shimadzu, Japan)  
X-ray diffraction- 6100 (Shimadzu, Japan)  
LCR meter 4908A (Agilent)  
Hall measurement System (Ecopia, Korea)  
RTP furnace (MTI, USA)  
Co-evaporation System





# School of Computer Engineering

With explosion of information and ever-increasing demand for computational sophistication in a networked world, the School of Computer Engineering aims to imbibe cutting-edge skills through research and development, industrial consultancy, and teaching in frontier areas of Computer and Informational Technology. The state-of-the-art facilities of the School include adequate number of air conditioned classrooms, laboratories and round-the-clock library with 13,000 books and numerous journals. It has its own conference hall, seminar hall and reading rooms.

The well qualified faculty members of the School aim to impart adequate understanding of fundamental concepts with a view to lay a strong foundation to help assimilate continual changes in the dynamic field; train in current technologies to be employable in the industry; train to connect theory with application; develop analytical, problem solving and product design skills; motivate to take up careers in research and development as well as in academics; and develop entrepreneurship abilities with a view to become self reliant.

Besides imparting high quality, innovative and continually updated UG and PG courses, the School is engaged in research in frontier areas. Research interests include Algorithms & Theory of Computation, Artificial Intelligence, Bioinformatics, Cloud Computing, Database & Data Mining, Human Computer Interaction, Information & Network Security, Internet Technology, Image Processing, Mobile Computing, Pattern Recognition, Program Analysis and Testing, Parallel & Distributed Computing, Real Time Systems, Service Oriented Architecture, Soft Computing, Software Engineering and Wireless Sensor Networks

## Academic Programme

Bachelor of Technology (B. Tech) in Computer Science Engineering	4 Years
Bachelor of Technology (B. Tech) in Information Technology	4 Years
Master of Technology (M. Tech) in Computer Science & Engineering	2 Years
Master of Technology (M. Tech) in Computer Science & Information Security	2 Years
Master of Technology (M. Tech) in Computer Science (Software Engineering)	2 Years
Master of Technology (M. Tech) in Computer Science (Data base Engineering)	2 Years

## Dual Degree Programme

B.Tech & M.Tech - Dual Degree	5 Years
B.Tech & MBA - Dual Degree	5 Years
Ph.D	
PDF	



## Laboratory

- Algorithm Design & Analysis
- Compiler Design
- Database
- Data Mining & Analytics
- Graphics & Image Processing
- Internet Technology
- Microprocessor Programming
- Network Programming
- Object Oriented Programming
- Programming (C, C++, Java)
- Software Design & Testing
- Soft Computing
- ERP (SAP Modules & ABAP)
- Research

# School of Computer Application



The School of Computer Application is devoted to the study and research in applications of Computer Science at graduate and post-graduate levels. Right from its inception as a separate School in 1997, diversification, focused growth and integration of earlier initiatives have been the mission of the School. It has produced 14 batches of young, trained and talented individuals, who have made their mark in the software industry. The School has always been on a high growth path to keep pace with the ever increasing importance of the major disciplines of study and current technology trends. The combination of competent faculty members, modern infrastructure and state-of-the-art technical resources give an edge to the school's graduates. The School has a modern laboratory to serve the teaching and research needs of the students and faculty of the School. Students' pursuit for knowledge is supported by the elaborate resources such as the Wi-Fi network, IBM E-Server series, AS-400 Thin-client servers and storage area networks. Dedicated labs with modules for Multimedia-Graphics and Communication skills training groom the young technocrats for their entry into the fast-paced corporate world of computers. Regular industry exposure and interaction with various disciplines under KIIT University are important value additions. Current areas of research can be broadly classified into the following categories: Image Processing, Networking, Data Mining, Bioinformatics, Wimax, Cloud Computing, Queueing Networks, Mobile Computing, Ad-Hoc Network, Wireless Sensor Network, Energy Efficiency Models, Cryptography, Computational Intelligence, Grid and Parallel Computing, Geo-Informatics, Open Source Technology Applications, Soft Computing

## Academic Programme

**M.C.A.**                      **3 Years**

**Integrated MCA**        **5 Years**

## Laboratory

**Wireless Lab**

**Oracle 10g Lab**

**Enterprise Computing Lab**

**Multimedia And Animation Lab**

**Project Lab**

**Open Source GIS Lab**

**Network Security Lab**

**Visual Studio Lab**

## Computing Resources

### Hardware & Software resources

IBM Blade Server with 15 Blade

IBM E-Server Series

IBM X-Series Servers – 36 Nos.

Cisco Catalyst 6509 Core Switch

D-link DFL 7210 Core Switch

Four layer D-link Stack switch for distribution



# School Of Architecture & Planning

The School of Architecture and Planning, KIIT University is rich in diversity, creativity, and scholarship. With a mission to educate future designers to shape collaborations, synthesize complexity, and catalyze transformation for public good and foster research in all scales of the built environment: local, regional, national, and international, KIIT school of Architecture and Planning offers full time course in architecture at undergraduate level. There is proposal for floating a Master Degree programme in Urban Planning in the coming years. With a competent faculty prominent across the breadth of the field, students are exposed to many different approaches to Architecture, Design and Planning. Critics and theorists from around the world supplement the faculty, and together, they introduce students to issues and trends in contemporary architectural design and practice. Both theory and studio sessions being viewed as core of the program, the School brings together the expertise of architecture, industrial design, interior design, landscape architecture, urban design, visual communication design, and environmental science, with relevant subjects from arts, humanities, engineering and technology. Among others, these skills include drawing, architectural applications, technical and managerial seeking. With a strong foundation of as built environment consultants par responsibility and accountability

## Academic Programme

Bachelor in Architecture (B. Arch) - 5years



# Kalinga Institute of Medical Sciences



*(Approved by Medical Council of India (MCI))*

Kalinga Institute of Medical Sciences (KIMS), a constituent of KIIT University, offers a unique combination of experience and expertise. Located in an ultra-modern and eco-friendly campus, it has three wings-The Hospital, the Medical College (for MBBS & MD course) and Biomedical Technology Unit. The Medical College offers MBBS course at the undergraduate level with an annual intake of 100 students. A high academic standard is maintained by an experienced and dedicated team of Professors, Clinicians and Scientists, who are engaged in teaching, research and developing technologies in health care. The course is approved by the Ministry of Health and Family Welfare, Government of India and Medical Council of India (MCI). The Medical College has 25 academic departments, providing the study, treatment and prevention of human diseases and maternity care.

## Departments

- Orthopaedics
- ENT
- Obstetrics & Gynaecology
- Paediatric Surgery
- Endocrinology & Diabetology
- Ophthalmology
- Anatomy
- Pharmacology
- Anaesthesia
- Physiology
- Forensic Medicine
- Biochemistry
- Community Medicine
- Pathology
- General Medicine
- Nephrology
- Gastroentology
- Microbiology
- Radiodiagnosis
- Paediatrics
- Dermatology and Venereology
- Psychiatry
- Pulmonary Medicine
- General & Laparoscopic Surgery
- Dental Surgery



## Academic Programme

M.B.B.S. 4 ½ Years

PG Medical (MD) 3 Years

MD - Anatomy/Physiology/Biochemistry/  
Microbiology/Pharmacology/Pathology/  
Community Medicine.





# Pradyumna Bal Memorial Hospital Kalinga Institute of Medical Sciences (KIMS)

**1300 Bedded Multi Speciality Hospital**

*Health care with healing touch*

The hospital, attached to the medical college, has earned reputation as an affordable hospital with modern facilities. Key features of the hospital are:-



## **Key Features**

- Pediatric and Neonatal ICU with
  - Ultramodern ventilator facility
  - 16 Modern Operation Theatres
  - 24 hour Casualty and Trauma Care
  - 24-hrs ambulance service (including high end service)
  - 8 Computerized Dialysis Machines
  - Electroencephalography (EEG), Brain atlas and base of Skull surgery, EMG study
  - Phaco Emulsification
  - Digital Funds Cameras
  - State of the art 'Laser treatment' in Ophthalmology and dermatology
  - All Laparoscopic Surgery
  - Total hip and knee replacement
  - Arthroscopic Surgery
  - Sophisticated Spine Surgery
  - Snoring Surgery
  - Ultra modern immunization center
  - 24 hour blood bank facility
  - State-of-the-art Retinal Surgery
- 1300-bedded Multi-speciality Hospital
  - 400 beds reserved for poor (BPL) patients
  - 100 air-conditioned cabins & 50 air conditioned sharing cabins
  - 100 ICU Beds





### Super - specialty Services

- Nephrology
- Cardiology & Cardiothoracic Dept.
- Pediatrics Surgery
- Gastroenterology
- Oncology & Onco Surgery
- Plastic & Cosmetic Surgery
- Urology
- Neurology & Neuro Surgery
- Endocrinology
- Rheumatology and other specialty services

### Radio Diagnostics

- 64-Slice CT Scan
- 1.5 Tesla MRI with 45 Software application
- Digital X-Ray
- Ultrasound & 4 D Ultrasound
- Bone Densitometry (DexaScan)

### State-of-the-art Central Laboratory & Radio Diagnostics

- Clinical Capillary Electrophoresis
- Cancer Markers & Sex Hormone investigations
- Automated HB Testing System
- Fully Automated Biochemistry Analyzer
- Fully Automated Coagulation Analyser
- Fully Automated Blood, Body Fluid & TB Culture System
- Frozen Biopsy
- All other clinical investigations

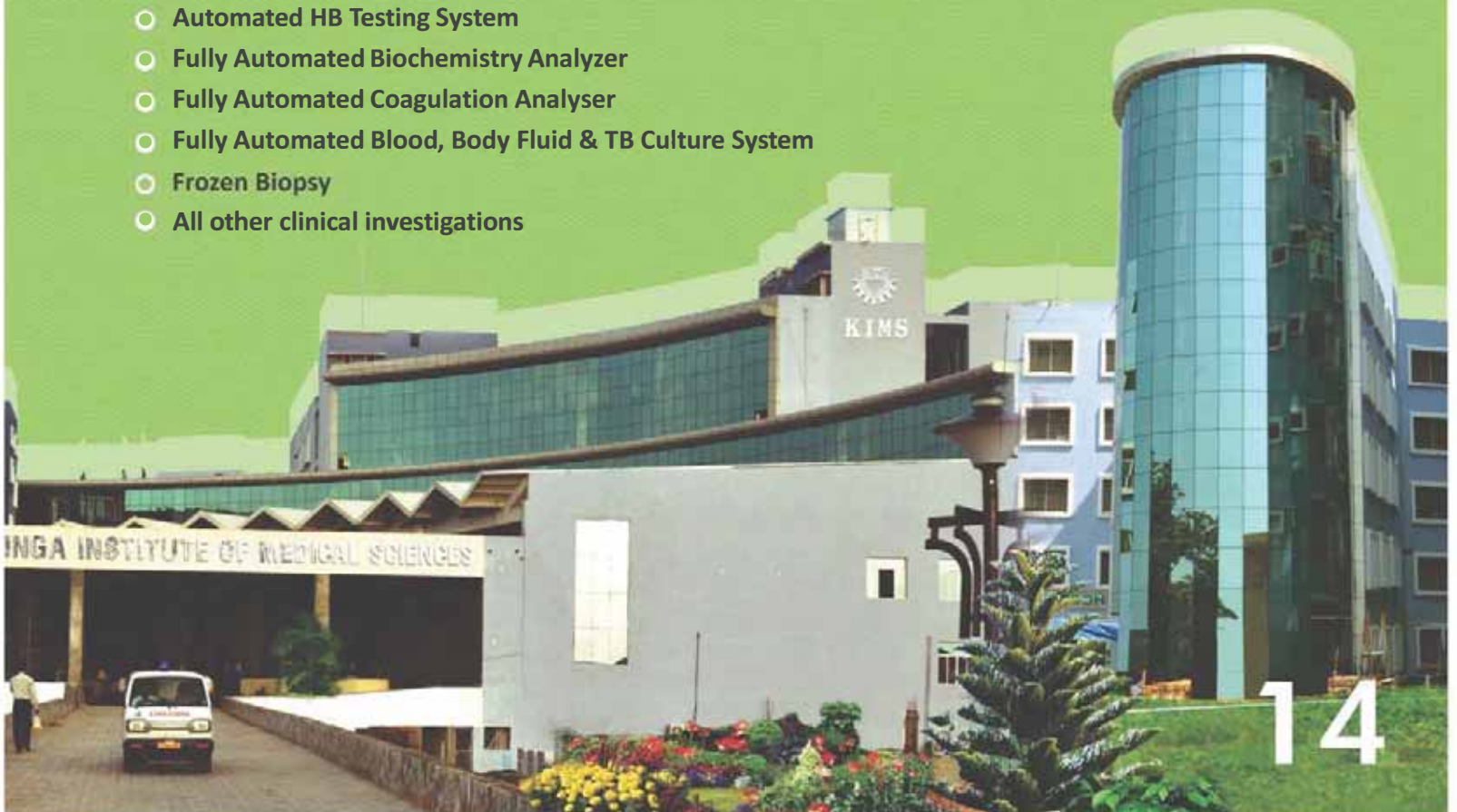



# Kalinga Institute of Dental Sciences

*(Approved by Dental Council of India (DCI))*

Founded in the year 2007, Kalinga Institute of Dental Sciences (KIDS) is on its way to become a world-class Dental College & Hospital in Bhubaneswar. Since its inception, it has steadily progressed as a major force in the field of dental education and oral health care.

In a short span of six years, KIDS has earned goodwill and reputation among the student community and patients. Today, it is a premier dental institution with the state-of-the-art infrastructure and highly qualified and experienced doctors delivering quality education and best dental care for the people of Odisha and beyond

## Academic Programme

Bachelor of Dental Surgery (BDS)\*  
4 Years + 1 Year Paid Rotatory Internship

## Departments

- Oral Medicine & Radiology
- Oral & Maxillofacial Surgery
- Oral & Maxillofacial Pathology
- Periodontics & Oral Implantology
- Prosthodontics and Crown & Bridge
- Conservative Dentistry & Endodontics
- Pedodontics & Preventive Dentistry
- Orthodontics & Dentofacial Orthopedics
- Public Health Dentistry

## Facilities

The School has six well laid out smart air conditioned Lecture Theatres with a capacity of 120 each. The LTs are designed as per international standard and teaching is imparted with the help of the most sophisticated teaching aids.

It has a well-furnished air conditioned Dental Auditorium that can accommodate over 300 people, where CDE programmes, conferences and functions.

The School has a spacious and resourceful library containing large volumes of textbooks, reference books and National and International journals for the benefit of staffs and students.

Each of the nine dental departments has reception area, clinical section, individual faculty rooms, seminar room, store, sterilization room, and well-equipped pre-clinical and clinical laboratories.

There are separate hostels for boys and girls within the college campus. Each hostel has attached canteen that serves good quality food.

All the major students' areas, including the hostel rooms and libraries, are provided Wi-Fi access through a secure wireless network.





# Dental Hospital

KIDS is also an one-stop solution dental hospital in Bhubaneswar providing patients access to impeccable expertise and superior personalized service. The hospital boasts of having the most modern equipment and technology, an integrated team of doctors and trained hospital staffs who are dedicated to providing the highest standard of patient care. It has reputation as a patient friendly hospital that offers advanced treatment at a very affordable cost.

## Facilities

- More than 200 ultra modern electronically operated dental chairs
- Well-equipped laboratories
- Cone Beam Computed Tomography (CBCT) – First of its kind in Eastern India
- Orthopantomogram (OPG) and Digital Radiovisiography (RVG)
- Minor Oral Surgery Operation Theatre
- Periodontal surgery unit
- Endo surgery unit
- Pediatric surgery section
- Implant clinic
- Cleft lip and Palate Management Unit
- Conventional and Lingual Orthodontics
- Oral Cancer Screening and detection centre

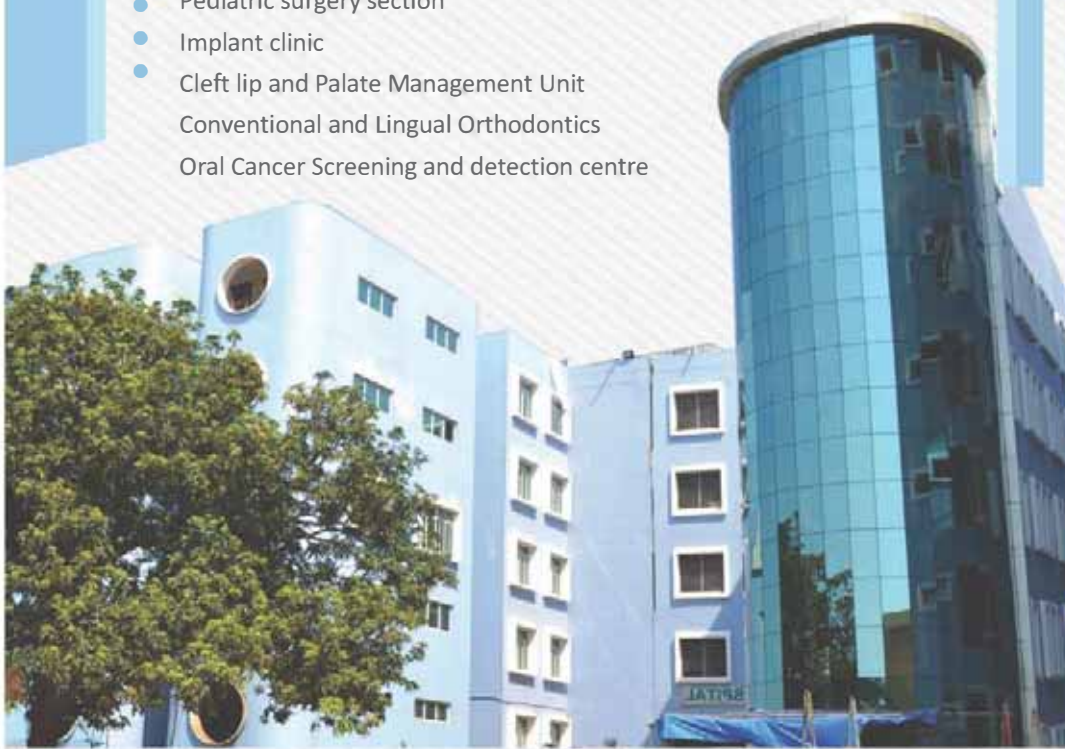
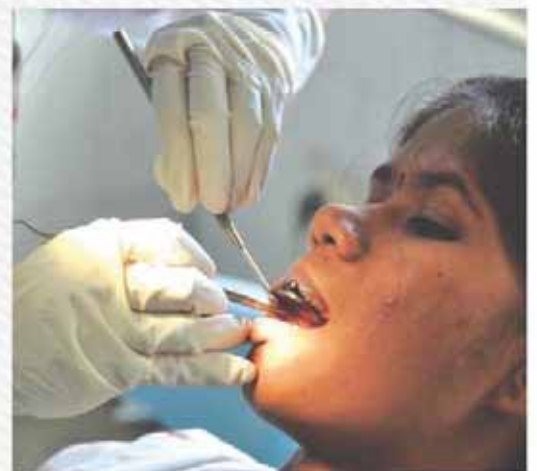

# School of Nursing

(Approved by Indian Nursing Council)

The Basic B.Sc Nursing (Bachelor Degree in Nursing) Programme is an holistic model of education conceived and enriched with new perspectives. The Diploma Course in General Nursing and Midwifery is geared to the health needs of the individual, family, community and the country at large. The aim of the programmes is to prepare graduate nurses so that they assume responsibilities as professional competent nurses and midwifery in providing promotive, preventive curative and rehabilitative services. They also prepare nurses to assume the role of teachers, supervisors, manager in clinical/public health setting. KINS has a qualified, experienced and intellectual team of faculty members to enrich the academic ambience.

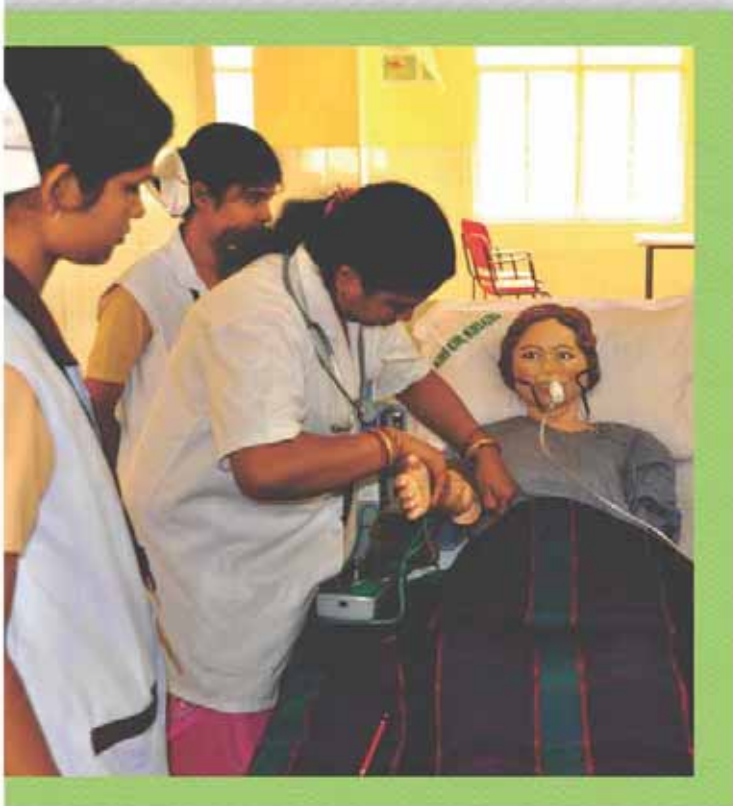

## Academic Programme

B.Sc. Nursing	4 Years
M.Sc. Nursing	2 Years
Diploma in General Nursing & Midwifery	3 ½ Years

## Laboratory

- Fundamental Nursing Lab
- Community Health Nursing Lab
- Nutrition Lab
- Bio-Sciences lab & Maternal Child Health Lab
- Computer Lab
- A.V. Aids Lab



# School of Biotechnology

School of Biotechnology heralds a new era of science with a broad vision in Eastern India. Its foundation stone was laid by Prof. Richard R. Ernst, Nobel Laureate and inaugurated by another Nobel Laureate Prof. Rolf M. Zinkernagel in 2007. The School has come up as a strong academic and research based organization in the country. It has established strong National and International collaborations (ETH Zurich, Switzerland; UNIL, Switzerland, Texas A & M University US; University of Florida, US; EAWAG, Dubendorf, Switzerland; University of Lund, Sweden; University of Giessen, Germany; University of Erlangen, Germany; London School of Hygiene.

The School is running 37 number of research projects sponsored by various national and international funding agencies such as UBS Optimus Foundation Switzerland, Melinda Gates Foundation, DBT, DST, CSIR, ICMR, ICAR of Govt of India. Various sophisticated and advanced research facilities are being established for carrying out research in the field of infection biology, vaccine development, cancer biology and therapy, environmental biotechnology Genome instability, Diabetic Retinopathy, nanobiotechnology, Composite material, Bioenergy. The School has been organizing national and international conferences regularly. In 2013, it organized 6th World Congress on Preventive and Regenerative Medicine, 14-16 November, 2013. It was inaugurated by Prof. Oliver Smithies (Nobel Laureate in Physiology or Medicine, 2007) in presence of Dr. V. M. Katoch, DG, ICMR, Govt. of India. School of Biotechnology is recognised by FIST Programme of Department of Science & Technology (DST), Govt. of India. As a part of curriculum, students are encouraged to do their final semester thesis in most reputed national as well as international institutions/laboratories. Currently 59 students are doing their PhD work in the school of Biotechnology with having fellowships from CSIR, UGC, DST-INSPIRE, ICMR and several sponsored projects.

## Academic Programme

**M.Sc. Biotechnology** 2 Years

**M.Sc. Applied Microbiology** 2 Years

**Biotechnology-Dual Degree  
(B.Tech/M.Tech)** 5 years

## Research Programme

Ph.D.

PDF



## Laboratories

Several advanced and equipped laboratories are established and running in the School of Biotechnology. They are

- Microbiology Lab
- Analytical Lab
- Molecular Biology Lab
- Plant Tissue Culture
- Animal Tissue Culture Lab
- Zebrafish Lab
- Protein Lab
- Bioprocess Engineering Lab
- Bioinformatics Lab
- Central Instrumentation Lab
- Animal house
- Microscopy lab
- Immunology lab
- Infection biology lab
- Bioenergy lab
- Chemical Engineering lab
- Environmental Biotech lab
- Cancer Research lab
- Diabetic Retinopathy lab
- Nano material lab



# School of Law

*Approved by Bar Council of India (BCI)*

KIIT School of Law was established by KIIT University in 2007 to meet the growing demand for legal professionals in the wake of globalization and rapid expansion of India's economy. Academic programmes of the School are recognized and approved by the Bar Council of India (BCI), the apex body regulating the legal education in India. At present, KSOL is the only law school in India having specialized Honours courses in Business Law, Constitutional Law, Crime & Criminology, Intellectual Property Law, Taxation Law and Human Rights Law. The School is fortunate to have the guidance of Prof. N. L. Mitra, former Director, National Law School of India University, Bangalore who is also the Chairman of the Advisory Committee of this School. Prof. J. Martin Hunter, a Barrister at the Essex Court Chambers, London and the Professor of International Dispute Resolution, Nottingham Trent University and an expert on international arbitration is another guiding force behind the development of KIIT School of Law. The School has collaboration with the leading international law education consortiums including the International Association of Law Schools, Washington, USA and Asia-Pacific Association of Law Schools, Australia.

## Academic Programme

B.A.LL.B.	5 Years
B.Sc.LL.B.	5 Years
BBA.LL.B.	5 Years
LL.M	1 Year
Ph.D	
PDF	





# School of Management



KIIT School of Management (KSOM) is a unique institute that moulds young dynamic minds to assimilate corporate and management expertise and imbibe the skills, while simultaneously enabling sensitization to the ever changing global scenario. KSOM provides an environment which awakens the young minds and fosters in its students a rational and responsible attitude. This helps in developing multifaceted capabilities to deal with challenges of the industry. The curriculum imparts holistic education in leadership while catering to one's academic needs. Students are equipped with the analytical and leadership skills needed to maximize the impact they make when they start working.

## Academic Programme

<b>Bachelor of Business Administration (BBA)</b>	<b>3 Years</b>
<b>Master of Business Administration (MBA)</b>	<b>2 Years</b>
<b>MBA (Part Time)</b>	<b>3 Years</b>

### The School also offers Certificate

Programme in General Management, Management Development Programme & In-Company Programmes.

## Research Programme

PhD

PDF





# School of Rural Management

The KIIT School of Rural Management (KSRM), Bhubaneswar came into existence with the laying of the foundation stone by the Father of the White Revolution, Late Dr. Verghese Kurien and Dr. A.Samanta, th Founder of KISS and KIIT Group of Institutions on 20 November 2006. The KSRM vision is to use knowledge driven approach to become a leading Global Academic Institution in the field of Rural Management. Its mission is to catalyze the process of sustainable and holistic rural development and minimize existing rural-urban divide. KSRM strives to achieve its mission through teaching, training and research in the field of rural management and educating a new breed of professional rural managers having appropriate values and ethos to help rural organizations and institutions in professional management. KSRM offers a well-structured two-year MBA Program (Rural Management) with substantial experiential learning component to educate the budding rural managers for meeting the managerial requirements organizations working for rural people. Besides its flagship programme KSRM is also engaged in Research, Consulting and Training. KSRM is a unique partnership Education model in Rural Management wherein KSRM closely works with nearly 250 Organizations in Govt., Semi-Govt., NGO & Corporate sectors spread all over the country. These organizations provide learning platform to our students and in turn gain from their research inputs as interns and hiring them as professionals.



## Academic Programme

**MBA in Rural Management**

**2 Years**

**Research Programme**

**Ph.D.**

**PDF**



# School of Film & Media Sciences

Film and television media have expanded exponentially after the introduction of a number of TV channels in Hindi, English and regional languages. In order to cater to the needs of the film industry and television channels, KIIT University has set up the School of Film and Media Sciences. With the state-of-the-art infrastructure, leading industry professionals as the faculties, expert advisory panel as mentors, project based curriculum and industry internship, the School helps students acquire multiple skills to meet the multi tasking requirements of film industry and media organizations. The students of the School receive hands on skills on Screen Writing, Directing, Camera, Lighting, Audio recording, Audio designing, Editing, Post production, Animation, Production designing, etc. Theory and practical workshops are conducted throughout the course under the guidance of well trained faculties and reputed award winning industry professionals

## Academic Programme

Bachelor in Film & Television Production (BFTP) 3 Years

## Specializations

Cinematography  
Editing  
Direction  
Animation  
Screen Writing  
Audio Recording and Designing  
Production Management

## Academic Support Facilities

Computer lab  
Animation Lab  
NLE Editing Lab & Sound Studio  
Still Photography Lab  
Multi Media set up  
Classroom Theatre  
Gym/Yoga Centre  
Auditorium  
Audio Studio





# School of Fashion Technology

KIIT has established School of Fashion Technology from the academic year 2009. The School caters to the national and international students aspiring to be Fashion Design Graduates. KIIT School of Fashion Technology fulfils the long-felt need of such school under a reputed university in this part of the country. The School will also dedicate and focus itself for creating professionals of par caliber who would like to make a mark in the booming Retail Sectors. The course offered by School of Fashion Technology will enable the students to learn design through extensive theory classes, intensive practical, field visits, market survey, Craft Documentation, Industry Internships & Portfolio Development. The School is determined to create a centre of excellence with qualitative educational, creative exposures, conceptualization skills and technical expertise, well- researched teaching methodology, industry Linkages and intellectually stimulating cosmopolitan environment.

## Academic Programme

Bachelor of Design (Fashion / Textile) 4 Years

## Laboratory

Pattern Making Lab  
Garment Construction Lab  
Cad Lab  
Tie, Dye & Batik Lab



# School of Fine Art

KIIT School of Fine Art is a new initiative of KIIT University. The School draws its inspiration from Odissan culture which has dissipated the message of social harmony and peace from time immemorial through its rich and vibrant monuments. KIIT School of Fine Art will strive to provide freedom for art creativity to students drawn from different parts of the world. Under the leadership of Prof. Adwait Gadanayak, an internationally acclaimed sculptor, as its Director, KIIT School of Fine Art will have curriculum and facilities comparable to the best art schools of the world.

## Academic Programme

Master of Fine Art (Sculpture)



## Kirti-Kalpa – KIIT Art Gallery

*Kirti-Kalpa is a national level art gallery displaying traditional and contemporary sculptures and paintings. It has been conceptualized and maintained by Adwaita Gadanayak, internationally acclaimed sculptor.*



# Centres of Excellence

## Central Advanced Research Centre

Central Advanced Research Centre has been established in 1.5 lakh sq. ft. built up area with sophisticated equipments for advanced research.

## Innovation and Entrepreneurship Cell

KIIT has set up Innovation and Entrepreneurship Cell to provide technical knowledge and facilities for starting technology driven enterprises as well as doing research for producing cost-effective techniques. It fosters entrepreneurship amongst students and assists budding entrepreneurs by providing them with necessary resources.

## Centre for Industry Institutional Interface

Centre for Industry Institutional Interface has been set up to devise strategies for the promotion of synergistic interface with industry. It also sensitizes the academia towards needs of the industry, besides organizing events involving the industry.

## KIIT-TBI

A Technology Business Incubator is housed in KSBT, which is supported by DST, MSME, DIT, Govt of India. Six incubatees have graduated from the centre so far, while 20 start up incubatees – 14 in-house and six virtual - are working in the TBI centre. The centre is playing a major role in technology commercialization and setting up of enterprises.

## BDTC

Biogas Development Training Centre (BDTC) is also established in School of Biotechnology, sponsored by Ministry of New and renewable energy (MNRE). The centre is involved in technology development for biogas production and conducting training programs.

## Centre for Children's Studies

Centre for Children's Studies is a joint initiative of KIIT University and UNICEF. It aims to strengthen the existing systems to promote strategic knowledge management and building a knowledge base on children's and women's issues concerning the state of Odisha with focus on social inclusion. Through this Centre, KIIT and UNICEF will work together to develop platform and system to promote generation, analysis and sharing of strategic knowledge that inform policy and programme.

## Centre for Innovation and Research and Research & Development (CIR and R&D) Cell

CIR and R&D Cell has been established to achieve the strategic goals of KIIT University and to promote identity of the University as a modern, dynamic, research-intensive and learning institution as well as to enhance the University's activity and profile in graduate studies and research. The Cell has been instrumental to organize international and national conferences where agglomeration of laureates worldwide have delivered vital and essential information. The Cell has earned fund sanction from Government and industries towards research.

## UMAP National Secretariat

University Mobility in Asia and the Pacific (UMAP), dedicated for the cause of University level education in Asia and the Pacific, is an association of government and non-government organizations which administer student mobility in order to enhance international understanding among university students in 34 member countries with more than 364 participating Universities in the region of Asia and the Pacific. KIIT University has the unique distinction of housing UMAP National Secretariat of India.

## Open Source Drug Discovery Centre

Open Source Drug Discovery (OSDD) is a venture of Council of Scientific and Industrial Research (CSIR) team India consortium with a vision to provide affordable health care with discovering novel therapies for neglected tropical diseases such as tuberculosis and malaria. The School of Biotechnology (SBT), KIIT University has been selected as one of the centre to engage in research activities on drug discoveries for Tuberculosis.

### **IBM KSOM Centre of Excellence**

KSOM has partnered with IBM to avail training activities and provide software and support for its students and faculties through IBM-KSOM Centre of Excellence. The centre conducts faculty and student development programs, free of cost. Participants who complete the program successfully are deemed 'Subject Matter Experts' in the respective area.

### **Centre for Excellence for SAP (COE-SAP)**

COE-SAP, which functions in KIIT School of Management in alliance with SAP UA, provides SAP education to MBA students so as to make them perfect IT enabled business graduates to work not only in SAP client organizations, but also all other promising business environments meaningfully.

### **KIIT Centre for Environment and Global Sustainability (KIIT-CEGS)**

Established as a boundary organization, KIIT-CEGS's overall goal is to support and strengthen an enabling environment of knowledge co-production for evidence-based policy processes and governance at various levels in society. KIIT-CEGS has been associated with these processes through systematic research, timely communication, and effective societal engagements on various issues of human development.

### **ISTE Students' and Faculty Chapters**

ISTE Students' and Faculty Chapters functions in KIIT University to look after career development of faculties and personality development of students.

### **NBA East Zone Nodal Centre**

East Zone Nodal Centre of National Board of Accreditation (NBA) is functioning in KIIT University. The Centre trains resource persons in the University.

Central Advanced Research Centre

Innovation and Entrepreneurship Cell

Centre for Industry Institutional Interface

KIIT-TBI

BDTC

Centre for Children's Studies

Centre for Innovation and Research and Research & Development (CIR and R&D) Cell

UMAP National Secretariat

Open Source Drug Discovery Centre

IBM KSOM Centre of Excellence

Centre for Excellence for SAP (COE-SAP)

KIIT Centre for Environment and Global Sustainability (KIIT-CEGS)

ISTE Students' and Faculty Chapters

NBA East Zone Nodal Centre



# INTERNATIONAL PROGRAMME

As a progressive institution, KIIT University is sensitive to the growing trends of globalization of higher education. International interaction of KIIT University is not new. Way back in 2001, KIIT was one of the first institutions in the State of Odisha to attract foreign students into its various academic programmes. In subsequent years, their numbers grew steadily. At present student body of KIIT University has representation from over 22 countries, including most of the South Asian nations, proving that its reputation as a quality institution of professional education transcends borders.

KIIT University values the diversity that international students bring to campus in terms of culture, background and perspectives. A decade long exposure to international environment has led to the creation of infrastructure and support systems which are the most appropriate to welcome foreign students. The University has a proactive International Programme Cell, which provides guidance to international students right from their arrival in the institute in the matters of their cultural, legal and academic needs and other issues of relevance. Keeping in view the communication needs of the prospective students from South Korea, China, Thailand and Japan, the University has established a language lab to improve the communication skills in eight foreign languages including English. There is a dedicated hostel for international students with superior amenities.

Facilities and support services apart, a curriculum tuned to global standard is a major attraction for foreign students. In order to maintain such high standard, KIIT has roped in faculty and staff members from 13 countries.

## KIIT UNIVERSITY

International Relations Office, KIIT University  
At/PO-KIIT, Bhubaneswar-751024, Odisha, India  
Tel: +91 9937220249  
Email: [internationaladmission@kiit.ac.in](mailto:internationaladmission@kiit.ac.in)  
[Dwiti.vikramaditya@gmail.com](mailto:Dwiti.vikramaditya@gmail.com)

All the international quota seats will be filled up through KIITEE 2014.

Many students from various Schools of KIIT University are regularly selected in reputed foreign universities for higher education and internship. A majority of the students going for higher studies manage scholarship or fellowship from the host institutions, while internships are arranged under collaboration of KIIT with the host institutions. Some of the foreign universities where KIIT students are pursuing their higher education or have undergone their internship are:

Oxford University, U.K.

Cambridge University, U.K.

Asian Institute of Technology (AIT), Bangkok,

EAWAG Dubendorf, Switzerland,

Institute of Microbiology,

ETH, Switzerland,

Czech University of Life Sciences, Prague,

Lund University, Sweden,

European Master in Law & Economics

University Law College, University of London

University of Lyon (France)

Texas A&M University (USA)

Hanse University, South Korea.

## Fees for Foreign Students

A) For all courses excepting  
M.B.B.S., B.D.S. & Ph.D.

SAARC Region: US \$8000 per annum  
Other Countries: US \$10,000 per annum

B) Ph.D.: US \$4000 per annum

C) M.B.B.S.: US \$1,30,000 ONE TIME

D) B.D.S.: US \$45,000 ONE TIME

## Classroom

There is adequate number of classrooms in each campus for the 20000 students enrolled in KIIT University. Classrooms are air conditioned and designed as per international standards to ensure effective teacher-student interaction. They are also equipped with LCD projectors and a host of other contemporary teaching aids.



## Library

Library facility is provided from the independent library located in each School of KIIT University and a Central Library located in a self-contained independent campus. Central Library, located in a five-storied building spread over an area of 45,000 sq ft., complements the academic objectives of the institution through support for learning, teaching, scholarship and research, achieved by efficient and effective delivery of services. It has more than 2,00,000 latest reference titles on technical, management and related subjects as well as professional journals (both national and international). The reference section is updated with reprints of reports, monographs and compilation of classic articles on each of the courses taught here. All the libraries of KIIT are fully automated through LIBSYS, the leading Library Automation Service provider. The Central Library provides round-the-clock Reading Room facility.

As well as offering a full lending and enquiry service, all the libraries provide access to a wide range of information sources in a variety of media. The digital library provides access to CD based study materials, live video lectures by eminent professors from world class institutions and computer based tutorials. The web journal facility provides access to table of contents, abstracts and full text versions of major national and international journals. The Library-cum-Reading room complex also houses a Data Centre and two wireless labs.





# Campus Placement

Session: 2013 - 2014



Campus placement in KIIT University is excellent as the students are well-prepared to fit into the demands of the job market. It has been achieving record *Cent Percent* placements since 2001, when the first batch of Engineering students graduated. This spell continued in 2013 graduating batch of students despite the tough market conditions due to the rigorous training of the students, which helps develop strong foundation for the core academic competencies along with the high quality industry-deployable skills. To realize this in a systematic way, the University has started *KIIT Certification School*, where training-cum-global certifications partnering with the World-Class Industry leaders are offered. In addition to this, the students get wide professional exposure due to a vibrant schedule of academic conferences, seminars and symposiums, which are attended by the top academicians, scientists and industry personnel. Also, the excellent performance of the past graduated batches motivates the companies for repeat visits.

For 2013 graduated batch of students, 1708 job offers were generated by 174 companies which participated in the KIIT campus recruitment programme. Not only all eligible and interested students were placed but about 57 students from various Schools of KIIT University (Schools of Engineering, School of Computer Application, School of Rural Management, School of Biotechnology, School of Management and School of Law) were pampered with multiple job offers. Schools of Engineering and School of Computer Application, which have the highest number of students among all Schools of KIIT University, recorded cent percent placements. More than 80

companies from core, as well as IT sectors visited these Schools for the placements, since the campus was opened for Shapoorji & Pallonji in the month of July 2012. Some of the top corporate houses which participated in the campus recruitment drives are Microsoft, Intel, SAP, Tata Steel, Bhusan Steel, Tata Power, Steerling & Willson, Vedanta, Mu Sigma, Deloitte, Aricent, TCS, Accenture, Capgemini, Tricon Infotech, NTT Data, Siemens, Asiana Housing, KEC International, ERA Group, Tractors India Ltd, Genpact, Bergen Solar Power & Energy, Windowworld Energy, Agni Power, Kurlon, Tega Industries, Future Generali, Cinda Engineering, ISMT, Everest Industries, JKumar Infraprojects, Infotech Enterprises etc.

For sixth year in row, TCS had the distinction of being the top recruiter doling out 432 job offers to the students of Schools of Engineering and School of Computer Applications. This was the highest numbers of offers given by any single company to the institution in the Eastern India. The highest salary package in Schools of Engineering was Rs. 16.25 lacs per annum, which was offered by Microsoft and the average salary package for all the offers was Rs. 3.15 lacs per annum. This again proved that KIIT is one of the favored talent hunting ground for the corporate world including Fortune 500 companies, which visit only KIIT University in the state of the Odisha for the campus recruitments. To enhance these Industry-Institute linkages and overall knowledge economy at KIIT campus, University has also initiated *Industry Engagement Cell* with an objective to nurture and maintain symbiotic relationship with the industry and other external agencies.



School of Management had more than 45 corporate houses visiting for the campus placement and all eligible students got the job offers. The highest salary packages was Rs. 16.13 lacs per annum (offered by Metafix), while the average salary package for all the offers taken together was Rs. 3.90 lacs per annum. School of Rural Management recorded 100% placement with all 50 students placed in 20 organizations, both from development and corporate sectors. For the 1st time, KSRM student got placed in an overseas company Sagrocod India Pvt Ltd (part of Tanmondial Pte Ltd, Singapore) and the highest salary package offered was Rs. 9.2 lacs per annum.

As many as 23 students from School of Biotechnology got selected for national and international Universities and research organizations and taken together 43 students who preferred joining corporate world; the School recorded 100% placements. Total 19 companies visited KSBT for campus recruitments, which include B. Braun, Dabur, Nestle, Cadila, Glenmark, RPG Life Sciences, SRL, Bayer Pharma, Nuzivedu Seeds Ltd and St. Martha Hospitals.

Total 20 recruiters visited School of Law and offered jobs to 74 graduates, which include legal firms like Quislex, Zenith Lex and S. Jalan & Co, as well as corporate like Bajaj Allianz, Kotak Mahindra, ICICI Lombard etc. The School achieved cent percent placement second time in a row including few academic placements also. KIIT University uniquely places equal emphasis on the academic placements by meticulously grooming interested students for the higher studies and actively

supporting their efforts to secure admissions in reputed institutions. In line to this, KIIT has started few initiatives like CAAS - *Career Advisory & Augmentation Services*, which primarily encompass competency assessments and improvement activities including behavioral aspects of the students, *KIIT EDGE* - a comprehensive MBA preparatory programme, *EAM - Enterprise Applications Management Division* with an objective to provide the students with knowledge and experience in ERP, CRM, SRM, SCM & PLM areas and *KIIT School of Leadership* with an aim to provide preparatory training for Civil Services, Indian Engineering services and Judicial Services. Total 159 students from different Schools were academically placed, securing admissions in leading institutions of higher education in India and abroad like European Master in Law & Economics, University Law College - University of London, Oxford University, Cambridge University - London, ETH - Zurich (Switzerland), EAWAG - Dubendorf (Switzerland), University of Lyon - France and Texas A&M University - USA.

**KIIT University – The favourite talent hunting ground of the corporate world.**

# Academic Placement - 2013

KIIT University uniquely places equal emphasis on academic placement, meticulously grooming interested students for higher studies and actively supporting their efforts to secure admission in reputed institutions. Whether it is success in the prestigious Indian Institute of Management (IIM) or offer from top foreign universities, students of 2013 batch have performed exceedingly well. Scores of B.Tech students of 2013 passing out batch bagged call letters from IIMs, admissions to which are done through Common Admission Test (CAT), one of the most competitive entrance examinations of the country. Another B.Tech student secured 4th position in the prestigious Graduate Aptitude Test in Engineering (GATE). As many as 250 students from KIIT University were successful in GATE – 2013, bagging three ranks in top 100. With many others securing admission in reputed foreign universities, more than 300 students of Schools of Engineering were academically placed. Some of the prominent foreign universities in which they have been selected are University College, Dublin, Ireland; San Jose State University, California, USA; University of South California, USA and University of Pennsylvania, USA.

Continuing with its strong track record in academic placement, School of Biotechnology has been able to place 23 students in reputed national and international universities and research organizations. Seven students have been selected to for Ph.D. programme in reputed European and South Korean universities. Seven others joined national research institutions after clearing CSIR, DBT fellowship programs. Another nine students were offered research positions at ZSI, JNCASR, IARI, IGIB, KIIT University and NIPGR. Six students of School of Law preferred to opt for higher studies securing admission into leading Indian and foreign universities, including University of London, U.K., Oxford University, U.K. and Cambridge University, U. K.

## Placement for 2014 Batch - Highlights

*(As on December 15, 2013)*

Well known names of the corporate world rushed in as soon as the University opened the window for campus placement in August 2013 for 2014 graduating batch of students. Within only four months more than 60% of the students from the Schools of Engineering and School of Computer Application were placed. As many as 46 companies have visited KIIT University so far in the above Schools and Schools Management and Rural Management. With such an impressive beginning, KIIT University is set to achieve cent percent placement for 2014 graduating batch of students before the end of the session for yet another year.

## Companies Visited So Far

Accenture  
Adstuck  
Amazon India  
Annapurna Microfinance  
Argusoft  
Asahi Glass  
CapGemini  
Colgate Palmolive  
Cybage  
Deloitte  
Development Credit Bank  
Everest Industries

Gyansys  
HCL  
HDFC BANK  
HP R&D Lab  
Infosys  
Intel  
IPL  
Jaro Education  
Jindal Steel  
JMC Project  
Knowledge Consortium of Gujarat (KCG)

Mahindra & Mahindra  
Mother Dairy  
Mu-Sigma  
National Handloom Development Corporation (NHDC)  
Pantaloon  
SAP  
Shapoorji & Paloonji  
Softenger  
Tata Power  
Tata Steel  
TCS

TechnoServe  
The Elitist  
Trident Group  
UST Global  
Vegyan Systems  
Web Spiders  
Wipro  
XL Dynamics  
Zenga TV  
Zentron Labs  
Zeta Interactive  
Zybose



# Scholarship

Various types of Scholarship have been instituted by the University for encouraging the meritorious students. The quantum of scholarship and period of scholarship is subject to change from time to time.

## PRADYUMNA BAL MEMORIAL SCHOLARSHIP

The scholarship is instituted in the memory of Late Pradyumna Kishore Bal, Founder President of KIIT. Every year two poor and meritorious students are provided completely free education under this scholarship scheme. The Scholarship covers college fees, hostel fees including mess, books and any other ancillary expenses. The decision of the selection committee regarding selection of candidate will be final.

## KIIT-POVERTY-CUM-MERIT SCHOLARSHIP

KIIT has instituted Poverty-cum-Merit Scholarship for the poor and needy students. The amount and period of scholarship is decided based on the need of the selected candidates. The decision of the selection committee for selection of such candidates will be final.

## KIIT-MERIT SCHOLARSHIP

KIIT Merit Scholarship is provided to the University-Toppers (1st, 2nd & 3rd ) of each semester for six months.

## LIVING LEARNING PROGRAMMES

KIIT has launched a Living-Learning Programme for the M.Tech. students. This innovative programme has been initiated to benefit the post graduate students, who wish to supplement their income while being a student and gain experience in teaching/research. The sponsored candidates will not be eligible for this programme. The Programme is voluntary. The student, interested to take advantage of this programme, shall be required to give his/her option on the day of reporting. Selection shall be made on the basis of interview. The decision of selection board will be final. A selected candidate shall be given departmental work

of 12 hours per week. The continuation under this programme can be terminated at any time, if the opinion of the HOD/authority on the performance of a candidate is unsatisfactory. Number of such award is flexible and vested with the management of KIIT University.

## POSCO SCHOLARSHIP

Posco India provides scholarship amounting to USD 500 to five meritorious students of KIIT University every year.

## KIITEE MERIT SCHOLARSHIP

KIIT provides free education to the topper of KIITEE-2014 (Only for B.Tech.- 4 years and MBBS) if admitted at KIIT University.

In addition to this, KIIT provides scholarship to top 500 rank holders of KIITEE 2014 (B.Tech.) during his/her study period at KIIT subject to fulfilment of criteria.

For General Rank 1 to 100      Rs. 36,000 per annum

For Rank 101 to 500      Rs. 24,000 per annum

Toppers (Best Ten) Of Central & State Boards      Rs. 1,00,000 per annum



## Other Courses

(M.B.B.S.) For Rank 1 to 10  
Rs. 36,000 per annum

(All Other courses) For KIITEE Topper (Rank 1)  
Rs. 24,000 per annum

# FEE STRUCTURE

## Session- 2014 - 2015

Fee structure has been designed for different courses on the basis of self financing concept

Programme	Duration of the programme	Fees Per Semester
B.Tech.	4 Years (8 semesters)	Rs. 1,10,000/-
B.Tech & M.Tech - Dual Degree	5 Years (10 semesters)	Rs. 1,10,000/-
B.Tech & MBA - Dual Degree	5 Years (10 semesters)	Rs. 1,10,000/-
B. Arch.	5 Years (10 semesters)	Rs. 1,10,000/-
B.Tech. ( Lateral Entry)	3 Years (6 semesters)	Rs. 1,10,000/-
M.Tech.	2 Years (4 semesters)	Rs. 90,000/-
MCA	3 Years (6 semesters)	Rs. 90,000/-
M.Sc Biotechnology	2 Years (4 semesters)	Rs. 70,000/-
M.Sc. Applied Microbiology	2 Years (4 semesters)	Rs. 70,000/-
Integrated MCA	5 Years (10 semesters)	Rs. 90,000/-
BBA	3 Years (6 semesters)	Rs. 90,000/-
Bachelor of Design (Fashion / Textile)	4 Years (8 semesters)	Rs. 75,000/-
Bachelor of Film & Television Production	3 Years (6 semesters)	Rs. 75,000/
BA.LL.B / BBA LL.B / B.Sc. LL.B	5 Years (10 semesters)	Rs. 1,05,000/-
LLM	1 Year (2 semesters)	Rs. 62,500/-
MBBS	4½ Years (9 semesters)	Rs. 3,00,000/-
BDS	4 Years	Rs. 3,40,000/- per annum
B.Sc. Nursing	4 Years	Rs. 60,000/- per annum
M.Sc. Nursing	2 Years	Rs. 1,50,000/- Per annum
PG Medical (M.D)	3 Years	Rs. 5,20,000/- Per annum

In addition to the fees mention above, Rs. 62,000/- is to be paid (one time) at the time of admission towards Counselling, Registration, Admission kit, Laptop & Blazer.

# Registration & Examination Fees

**Registration Fees per Semester : Rs.1000/-**

**Examination Fees per Semester: Rs.1000/-**

Registration Fees for the 1st semester will be collected at the time of counselling and for the rest of the semesters, the registration fees will be collected at the beginning of each semester. Examination Fees will be collected during the Form Fill up for the Semester Examination.

## REFUND RULES

1. Anytime after admission, but before reporting/starting of the course : Total fees.
2. After the commencement of course, no refund will be allowed.
3. In all cases where the student has been admitted to the course after the commencement of classes through the waiting list or otherwise, their case will be considered after the commencement of classes.
4. In case of Foreign student candidates, the refunds will be made in accordance with Foreign Exchange Regulations.
5. Requests for withdrawals should be made in the prescribed application available in our website. Refund will be made only after the candidate has surrendered the ID card, Original Fee Receipt, Allotment letter, Fee estimate letter and the dues clearance certificate.

## EDUCATION LOAN

Joining KIIT ensures a high quality placement in future. Therefore Nationalized/Private Banks are coming forward to finance for all types of educational expenses of KIIT students including college fees, boarding charge, hostel messing charge and any other ancillary study expenses like purchase of computer, study materials etc. without any security.



# Ph.D / PDF Programme

There is an ever-growing need for sound technical education, research and consulting activities all around the globe. Hence, demand for scholars will continue to soar in the country for many decades to come. The overall objective of the Doctoral program is to identify and provide solutions to problem of relevance to the society, industry, academia and even to the Government. Special emphasis will be on adoption of appropriate technology coupled with indigenous innovations. The long-term goal of KIIT is to play a vital role in bringing to life the aspirations of the society through creation of leaders for the future. The doctoral program will seek to instill values, professional ethics and above all the knowledge that would enhance the individual's efficiency to work for a better future.

**Ph.D. (ENGINEERING/TECHNOLOGY):** Civil Engineering, Computer Science & Engineering, Electrical engineering, Electronics Engineering, Information Technology, Mechanical Engineering.

**Ph.D. (SCIENCES):** Chemistry, Mathematics, Physics, Biotechnology.

**Ph.D. (HUMANITIES & SOCIAL SCIENCES):** Economics, English (Literature and Linguistics), Sociology

**Ph.D. (MANAGEMENT):** Banking and Insurance Management, Business Economics, Entrepreneurship Management, Financial Management, Human Resource Management, Marketing Management, Organizational Behaviour, Strategic Management, Technology Management, Rural Management.

**Ph.D. (LAW):** Corporate Law, Criminal Law, Criminology, International Criminal Law, Family Law

## ELIGIBILITY

M.Tech. / ME /MCA /MBA / or an equivalent degree with minimum 60% marks or an equivalent Cumulative Grade Point Average (CGPA) Or M.Sc. / MA / M.Com./ LLM/ or an equivalent degree with minimum 55% marks or an equivalent Cumulative Grade Point Average (CGPA)

Or

B.Tech./ BE or an equivalent degree with a minimum of 60% marks or an equivalent Cumulative Grade Point Average (CGPA). Consistent excellent academic record is essential and a valid GATE score is desirable for students having B.Tech. /BE degree.

The selection will be made on the basis of performance in the written examination and interview as per the UGC guidelines.

**The Institute admits Ph.D. students under the following categories:**

**Regular Scholars:** Those who shall receive regular assistantships from the University or other recognized / approved sources viz. AICTE, UGC etc.

**Self-Supporting Scholars:** Those who shall not receive any assistantship.

**Sponsored scholars:** Those who are sponsored by government departments / reputed industries/ external research/ academic organizations. Such candidates must have been in service in his/ her respective organization for a period of at least three years and must provide a sponsorship certificate from the employer in the prescribed form at the time of applying.



### Financial Support

Teaching assistantships are available in all departments to meritorious candidates depending on the requirement of the department. A student receiving fellowship or assistantship is required to work on full time basis and assist faculty members of the department in teaching activity. He/She may be required to take theory, tutorial or laboratory classes and may assist the students in their project work. Students not receiving a fellowship or assistantship may avail work opportunities on campus in R&D projects and the Institute's academic program.

### Rate of Assistantship:

Rs. 10,000/- per month for 1st & 2nd Years

Rs. 12,000/- per month for 3rd & 4th Years

### Rate of Contingency:

For Humanities

Rs. 10,000/- per annum for 1st & 2nd Years

Rs. 15,000/- per annum for 3rd & 4th Years

### For other Disciplines

Rs. 15,000/- per annum for 1st & 2nd Years

Rs. 20,000/- per annum for 3rd & 4th Years

Other scholarships like UGC, CSIR, ICMR etc, may also be available to students who had qualified in these schemes and get admission in KIIT. In such cases, the assistantship will be as per the norms of the funding agency. Junior Research Fellows (JRF) appointed in the sponsored projects of faculty members are also required to apply and can be admitted in Ph.D Programme, if they satisfy the University norms. They have to appear the Entrance Examination if not qualified in any national level test such as GATE/NET etc.

### Duration

Financial support is initially for a period of one year. All financial support can be renewed on satisfactory performance. Maximum duration of financial support is ordinarily for 4 years.

### Admission Procedure

- I. Admission to all the categories of students will be on the basis of performance in the written examination and interview.
- II. In the case of 'external registration' candidates, the following additional conditions should be satisfied:-
  - A. The candidate must submit details of the facilities relevant to the research programme available in the organization where he/she is employed, duly certified by the sponsoring authority.
  - B. The candidates will have to submit a certificate from the sponsoring authority that the required facilities will be made available by the organization.
  - C. The bio-data of the external supervisor, if any, should be submitted for approval by the Vice-Chancellor through the Doctoral Research Committee (DRC and/or the Research Scrutiny Committee (RSC)

### Course Requirements

All Ph.D. students are required to register and successfully complete a minimum course credits as per the Ph.D rules of the Institute, details of which will be made available to the students at the time of admission. Curriculum and syllabus will be decided by the Research Scrutiny Committee (RSC). The RSC may consider full or partial remission of course work and residential requirement as considered appropriate in deserving cases.



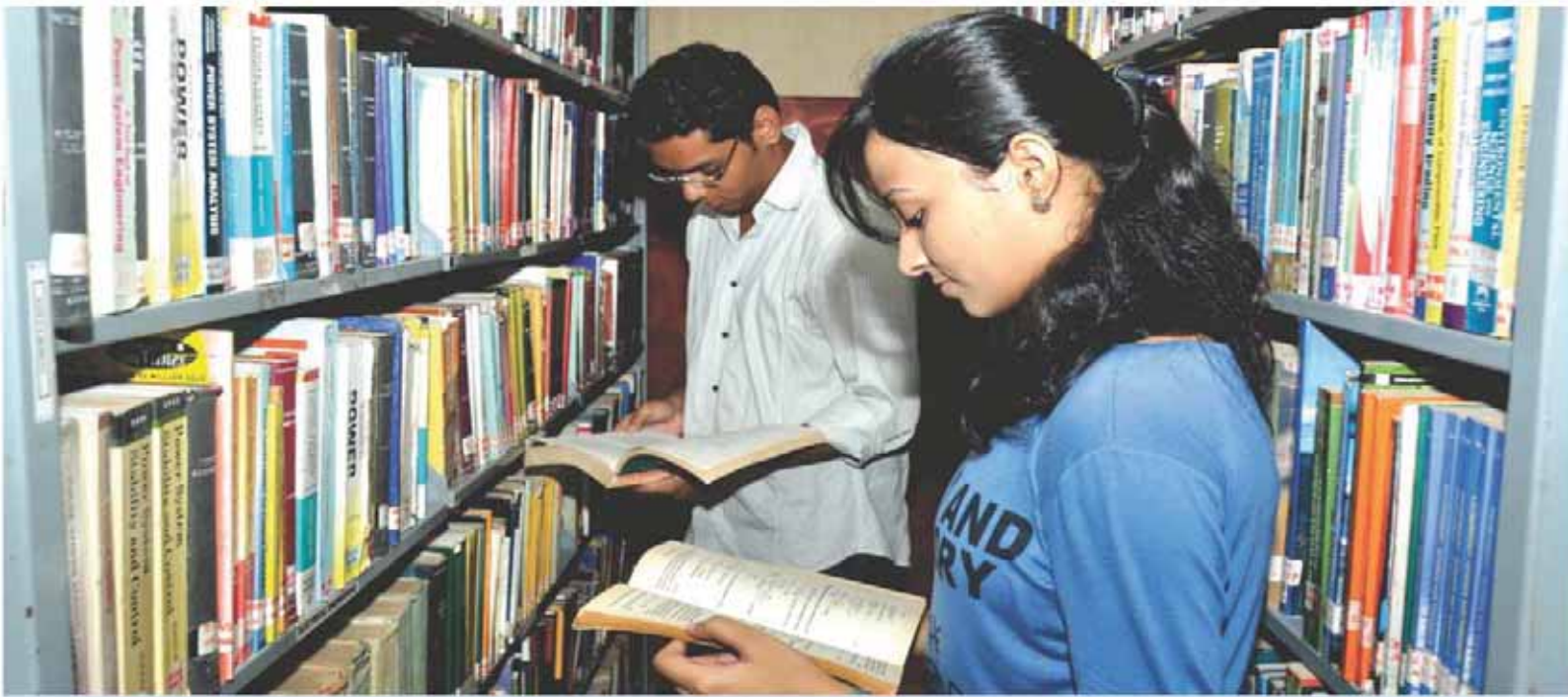

### Registration

A candidate is required to register with a specific faculty guide in a selected area of specialization at the time of enrolling for the programme with duly filled in application form along with documents and by paying the requisite fees. On successful completion of prescribed courses the candidate gets registered with effect from the date of enrollment or a semester later depending on the candidate's qualification (M.Tech or B.Tech) as the case may be. A similar rule will apply to M.Phil or M.Sc/M.A/M.Com/MBA/CA candidates. Subsequently, registrations are renewed at the beginning of every semester, subject to satisfactory progress in work. The prescribed fees must be paid each time as per the notifications.

### Residential Requirement

The minimum residential requirement is one year for regular & self-supporting category scholars. A candidate may be allowed, on the recommendation of Research Scrutiny Committee, to withdraw from the institute after completion of the course work (if any) and a minimum of one/two semester residential requirement, as the case may be, and to work externally at the place of employment. Nonetheless, he/she will have to continue the semester registrations at the institute till he/she submits the thesis.

### Annual Progress Seminar

All candidates must present the annual progress seminar each year. On successful completion of progress seminar, as certified by RSC, the registration will be renewed for the next year. The registration of non-performing candidates may be terminated after due warning.

### Semester Registration

All scholars either in the institute or externally in any industry / institute after taking withdrawal or otherwise must visit the KIIT complete registration formalities every semester in the month of July and January each year, & pay the prescribed fees

### General Information

1. Mere submission of the application does not qualify a candidate to be called for interview/test.
2. Admit Card for written test will be hosted for those candidates recommended by the department. Candidates may make personal inquiries, if they do not get admit card within a reasonable time.
3. Interview will be held for those candidates who qualify the written test.
4. Employed persons should send their applications through proper channel.
5. Separate applications to each department should be submitted if a candidate wishes to apply for more than one department.
6. All other terms and conditions will remain same as applicable for the KIITEE 2014.

## Fee Structure for Ph.D.

Students will be required to pay the following fees applicable to Ph.D. Program.

Sl No	Items	Amount (Rs.)
A.	One time payment.	10,000/-
B.	Semester Fees	10,000/-
C.	Thesis Examination Fee (To be paid during thesis submission)	
1.	Thesis submission & examination fees	30,000/-
2.	Viva-Voce Fees	5,000/-
		Total C 35,000/-

Please refer to Hostel section of this prospectus for hostel charges and other details

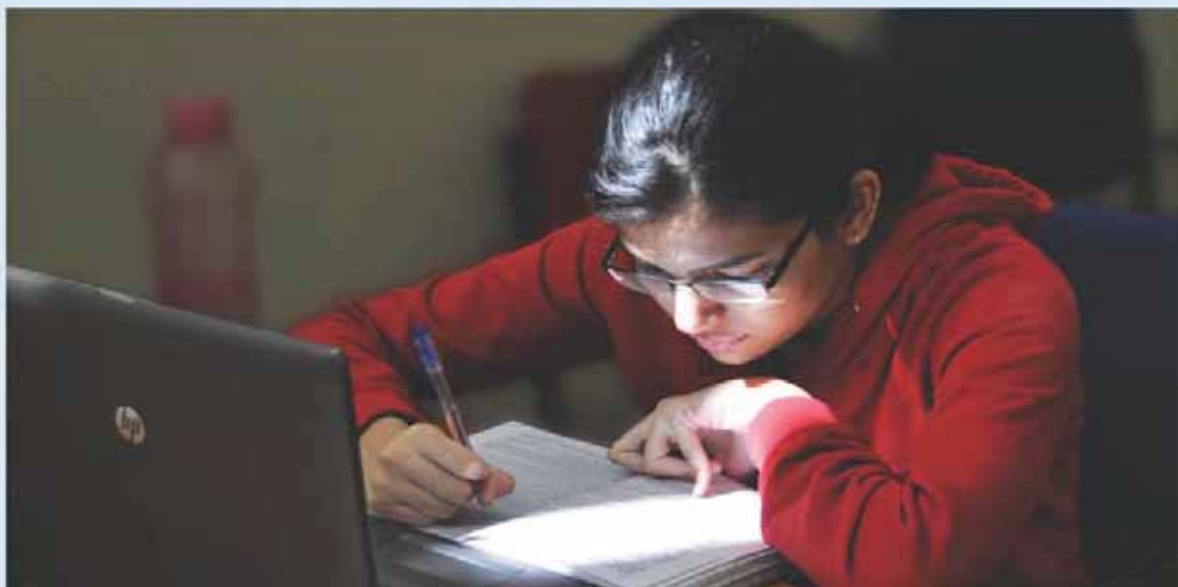

## Post Doctoral Programme

KIIT will also consider eligible candidates as Research Associates(RA) willing to carry out advanced research in the fields of Engineering & Technology, Management, Science and Humanities & Social Sciences. The candidate must hold a Ph.D. degree in relevant area and aged below 35 years. The candidate has to apply in the prescribed form with three copies of the research proposal along with 3 recent published works in journals. Each research associate will receive a monthly fellowship of at least Rs 20,000/- and a yearly contingency of Rs. 15,000/- The RA may be inducted as full fledged faculty to teach B.Tech & M.Tech students with a minimum of 15 hours workload per week.



# HOSTEL

There are separate hostels for boys and girls with round-the-clock wireless internet and intranet connectivity. About 30% of the hostel rooms are air conditioned. All the hostels have attached canteens serving good quality Indian and Continental foods. A dedicated international hostel accommodates foreign students. Each hostel has 24-hour reading room and facility for indoor and outdoor games.

- Hygienic Kitchen & Dining Hall
- Round the clock Internet and Intranet Facility
- 24-hour Reading Room Facility
- Facility for all types of indoor and outdoor games
- Flooring with marble tiles
- Good quality Indian & Continental Food

## Seat Rent, Establishment & Electricity Charges :

- BA LLB / BBA LLB / Bsc. LLB / LLM / BBA / MBBS / BDS - Rs. 21,000/- per semester
- B.Tech. / Dual Degree (B.Tech & M.Tech) / Dual Degree (B.Tech & MBA) / B.Tech. ( Lateral Entry) / B. Arch. / M.Tech. / MCA / M.Sc Biotechnology / M.Sc. Applied Microbiology / Integrated MCA / Bachelor of Design (Fashion / Textile) / Bachelor of Film & Television Production / M.Sc. Nursing - Rs. 17,500/- per semester
- AC Hostel - Two bedded - Rs. 40,000/- per semester  
AC Hostel - Three bedded - Rs. 30,000/- per semester
- Hostel admission & other fees Rs. 7,500/- (one time)







# Facilities

It is universal truth that physical infrastructure and facilities are enabling factors for quality education. KIIT is well-known for its world-class infrastructure, even though it is a new institution. Not only each academic programme has a self-contained independent campus, but also KIIT has put in place ultra-modern facilities, like wi-fi multimedia air conditioned classrooms, virtual classrooms, video conferencing, state-of-the-art laboratories, close circuit cameras, swimming pools, gym & health club, many seminar halls, auditoriums and open air theatres, etc, for students' growth.

## Conferences & Seminars:

KIIT provides excellent ambience for national and international level conferences and seminars. Its Central Convention Centre Complex houses a world-class Auditorium having a seating capacity of 1600, besides a Guest House with 5-star facilities (42 suits), Conference Halls (18 Nos.), Exhibition Ground (5 acre) and Banquet Hall. It is the largest of its type in the state of Odisha and one of the best in Eastern India. In addition, there are well-equipped auditoriums and conference halls in each campus. There are 20 Open Air Theatres (OATs) in different campuses having capacities ranging from 500 to 50000.

## Sports:

As a university with a vision, KIIT promotes sports and games among the students and staff. Sports activity in KIIT University is facilitated by KIIT Stadium, Central Indoor Stadium and 10 sports complex distributed in different campuses. Sprawling over an area of 29 acre, KIIT Stadium has the capability to hold day & night matches and can seat upto 40,000 spectators. It

has facility for Cricket (turf wicket), Hockey (astroturf), Kabaddi, Football, Volleyball, Kho-Kho, Throwball, Basketball, Rugby, Handball, Netball and Track & Field (400 m).

## KIIT's Central Indoor Stadium :

Biju Patnaik Indoor Stadium – is the hub for indoor sports activities. It is one of the biggest in-campus indoor stadiums of the country. It has facilities for Basketball, Volleyball, Table Tennis, Badminton, Billiards & Snooker (air conditioned), Chess, Carom, Health Club, 12 Station Multi-gym and Yoga Centre. In addition to these two central facilities, 10 Sports Complex are located in different campuses. Each such facility has a swimming pool, multi-gym, besides facility for other sports and games.

## Food Court:

There are 15 Food Courts specializing in cuisines from different parts of the world. They serve a wide selection of national and international dishes. These food courts are in addition to 20 canteens attached to as many hostels.

## Guest House:

KIIT has more than 105 comfortable suits in its guest houses situated around the campuses. This is in addition to 42 suits of the guest house located in the Convention Centre Complex.

## Health Care:

Health care in the campus in the campus, as well as beyond, is provided by a 1300 bed super speciality hospital attached to Kalinga Institute of Medical Sciences, a KIIT University constituent.

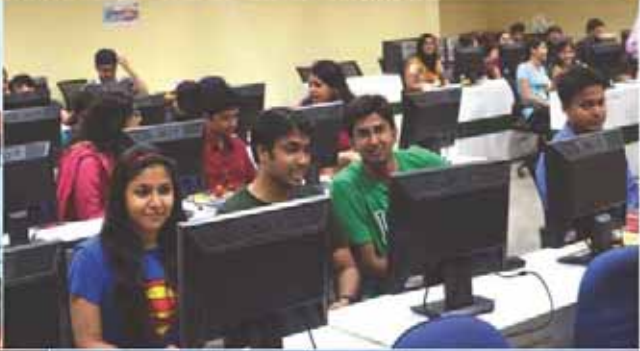

# ICT Facilities

KIIT University is at the forefront to adopt latest IT technologies using Information and Communication Technology (ICT) to support learning and teaching. KIIT provides each student with an email account that is accessible both on and off campus. Students also benefit from online learning platform like NPTEL, DSpace, EBSCO, etc for academic and research support. Students can access to over 3250 Desktop PCs based in as many as 41 laboratory centres across the campuses. The Library offers access to a significant number of Desktop PCs. Each student of the University is provided with a laptop to enhance the academic excellence along with regular facilities.

KIIT University has tied up with top IT service providers in order to provide the best services to the students, faculty and staff.

## Internet Facility with 1180Mbps

NKN  
Bharati Airtel  
BSNL

All the ISPs are managed with a managed Link Load Balancer at centrally located University Data Centre. Each campus is connected with dedicated optical fibre cable. University Network Integration Services and maintenance is managed by IBM India Pvt. Ltd.

## Networking

Cisco,  
Juniper  
Radware,  
CommScope  
Tyco Electronics

## Wi-Fi

Aruba  
Mororola  
Avaya

## Servers-IBM

Blade Server  
Rack Servers  
Tower Servers

## Uninterrupted Power Supply

APC  
Emerson

## Fully Wi-Fi Campus

All major students areas, including the hostel rooms, the libraries and catering outlets provide wi-fi access to a secure wireless network, while many areas provide 'transition zones' that blur the boundaries between learning and social computing activity.

## Software Resources

### Microsoft Campus Agreement

- Microsoft windows 7
- Redhat Enterprise Linux
- Ubuntu
- Mathematica
- oracle standard edition
- Matlab simulink
- signal processing tool
- communication tool
- Corel Draw Graphics Suit
- Z Brush
- Autodesk MAYA
- Adobe Production Premium CS5
- Prowess
- Economic Intelligence Service-Entire
- Industry Analysis Service
- IBM SPSS Modeler
- PLM
- CATIA
- 3 DVIA Vrtools
- Civil Design NBP & ULP
- Civil Survey NBP & ULP
- Clarity Infinity Software
- Fanuc OT & Fanuc OM
- Sanako Language Lab Software
- libsys
- Trend Micro Enterprise Security for Endpoints-Standard
- NI Labview
- IBM Rational RSA Programme(SEED)software

## Surveillance

CCTV camera with monitoring is available for the security of the student and staff across the University. As many as 2500 CCTV cameras monitors activities in and around different campuses of KIIT University.

# STUDENT ACTIVITY

KIIT University takes pride in celebrating creative attributes of human mind. It not only believes in imparting quality technical education, but also catalyzes an all round development of the student community through the various societies. These societies provide a Utopian platform to the students and ensure that the tremendous talent and potential embedded in today's youth are explored to the fullest extent and are put to use for the betterment of the entire society. Be it oratory skills or quizzing, music or arts, KIIT provides full scope to its students to explore the unexplored horizons and reach great heights.

## Kreative Eye-The Photography & Painting Society

Kreative Eye, the photography society of KIIT University provides a platform to the budding photographers and artists to showcase their talents. This society organizes several events like photography and painting competitions all the year round particularly on occasions like Independence Day, Republic Day, KIIT foundation Day and World AIDS day etc. This society also handles the posters for the various events that are held at KIIT.

## Korus - The Music Society

This group is specifically meant for the students who have a deep craving for exploring the intricacies of the musical notes. Korus is a haven for the budding musicians and equips the students with all the adequate resources for the proper channelization of their musical instincts. This community performs on all major occasions like Republic Day, Independence Day, KIIT Foundation Day etc.

## Kronicle - The Literary Society

Kronicle the literary society of KIIT University aims to provide a platform for the leaders of tomorrow to express their views. It's annual event "PRATIJA" is on Utkal Divas (April 1). Various colleges participate from across the country. The Society also publishes annual university magazine - 'KRITIKA'.

## Qutopia - The Quizzing Society

Qutopia is the quizzing society of KIIT University. It was founded in 2004. Born out of a desire to learn more about the world and beyond as well as an urge to share what we know. 'Udghosh' is the annual event of this society organized on 2nd October every year. Besides Udghosh, Qutopia also organizes several in-house quizzes such as "The Great India Quiz" that celebrates the various colours of our nation.

## KIIT Automobile Society

KIIT Automotive Society (KAS) was started in 2009 to give the student an active learning platform and increase their interest in the field of automobile. The Society has won prestigious competitions at national and international level.

## Society for Differently Abled

A society exclusively dedicated for the physically disabled helps people with disabilities get together. It helps them share their trauma, experiences and suggestions with others belonging in the same situation; thus contributing to their all round development.



### **Kalakaar - The Dramatics Society**

KIIT Dramatic Society provides a platform to hone acting skills, express views through various acts, drama, mimicry, stand up comedies, talks and events relating to this field. KIIT Dramatic society was started in 2011 and already has a significant number of productions. It has to its credit, performing in front of the Prime Minister of India and Prime Minister of Bhutan during their visits to KIIT.

### **Kartavya-KIIT Social Responsibility Cell**

Social Responsibility Cell acts as a motivator for young students to come together from all walks of life and join together to be the harbinger of light in the lives of those who have been deprived of it. Its flagship event last year - Kartavya, 2012 - focussed on one of the most pressing problems of today's society, illiteracy.

### **Konnexions - The IT Society**

The Information Technology Society deals with all aspects of information technology in industry, administration, teaching, research and science. Its primary aim is to promote the scientific and technical development of information technology and its practical application.

### **International Students Society**

KIIT International Student Society is a great source of social support and representation to sizeable international student body in KIIT University. It organizes various events during annual cultural function. It celebrates International Student Day 'Khesthen' every year with great joy.

### **KIIT Entrepreneurship-Cell**

KIIT Entrepreneurship-Cell is primarily responsible for fostering entrepreneurship culture amongst the students and assisting budding entrepreneurs by providing them with necessary guidance and resources.

# Social Events & Community Outreach

## **SPIC MACAY - KIIT Chapter**

A SPICMACAY chapter was formed at KIIT in May, 2003. The chapter has been successful in introducing some of the most renowned Indian classical musicians like Pt. Hari Prasad Chaurasia, Pt. Mukul Shivputra and Ileana Citristi to the KIIT community. These concerts are free and open to all and have served to spread awareness about Indian Classical music among a varied audience.

## **NCC**

Senior Division NCC (Army) exists in the University. Students of any wing can take part after going through the selection process.

## **NSS**

Two units of NSS, one for boys and one for girls with 500 students in each, are functioning in the University. The main aims and objectives of NSS units are to involve the youth in constructive and developmental programmes in rural society. This fosters national integration through community living and co-operative action. Annually a Chancellor's trophy is awarded to the best performing students in the respective field.

## **Enactus KISS-KIIT**

It is a community of student, academic and business leaders committed to using the power of entrepreneurial action to transform lives and shape a better more sustainable world.

## **Pratijja - War of the Words**

Pratijja is the annual national level oratory competition held at KIIT University. Its organised on the day of Utkal Diwas. Its organised by Kronicle, the literary society of KIIT University. Schools and colleges from various parts of the country participate in this event.

## **Founder's Cup**

Founder's Cup, the annual in-house oratory competition of KIIT University is touted to be an amalgamation of ideas, expressions, innovations and knowledge channels taken to the most premiere. Founder's Cup provides a formal platform for exposure among students and debating enthusiasts.

## **Kritansh-The Techno-management Fest**

It is the annual techno management festival of KIIT University, one of the largest such fests all over India, held from 14th to 16th February. Kritansh attracts participation from leading professional education institutions from all over the country.

## **Konkord-Inter School Personality Contest**

Koncord is the Inter School Personality Contest of KIIT University, held on 17th-18th February. The students from different schools of the University participate enthusiastically in the event.

## **A Ragging Free Zone**

KIIT University is a ragging-free campus. Ragging in any form is strictly prohibited and would attract severe disciplinary action and the punishment of expulsion from the University.

### Ragging has been defined as:

"Any act causing, inducing, compelling or forcing a student, whether by way of a practical joke or otherwise, to do any act which detracts from human dignity or violates his person or exposes him to ridicule or forbears from doing any lawful act, by intimidating, wrongfully restraining, wrongfully confining, or injuring him or by using criminal force to him or by holding out to him any threat of such intimidation, wrongful restraint, wrongful confinement, injury or the use of criminal force".

All students admitted to the KIIT University and their guardians are required to sign an undertaking that their ward will desist from indulging in ragging.



# Social Responsibility

## Social Responsibility

The humane face of KIIT is best illustrated in Kalinga Institute of Social Sciences (KISS), a protégé of KIIT. KISS, the largest tribal institute of the world, provides food, accommodation, health care and all the basic necessities of life absolutely free to 20,000 poorest of the poor tribal children to pursue their studies here from KG to PG as well as vocational training. KISS as an unique experiment to eradicate poverty through education and use of education as a tool to empower the underprivileged section of the society and provide sustainable employment is being hailed by statesmen, policy makers, planners, social workers from India and abroad.

**KISS-A Step  
Ahead Towards  
Social Commitment**



Every indigenous (tribal) child who comes to KISS, goes back to his family as an educated, economically independent and socially concerned individual.





## **KIIT University**

At/PO-KIIT, Bhubaneswar - 751024. Odisha, INDIA

Tel: +91 674 2742103, 2741747; Fax: +91 674 2741465

Email: [admission@kiit.ac.in](mailto:admission@kiit.ac.in); Website: [www.kiitee.ac.in](http://www.kiitee.ac.in), [www.kiit.ac.in](http://www.kiit.ac.in)