

2005
PH : Physics

Duration : Three Hours

Maximum Marks :150

Read the following instructions carefully.

1. This question paper contains all objective questions. Q.1 to Q.30 carry **one** mark each and Q.31 to Q.80 carry **two** marks each. Q. 81 to Q. 85 each contains part "a" and "b". In these questions, parts "a" as well as "b" carry **two** marks each.
2. Answer all the questions.
3. Questions must be answered on special machine gradable **Objective Response Sheet (ORS)** by darkening the appropriate bubble (marked A, B, C, D) against the question number on the left hand side of the **ORS**, using **HB** pencil. **Each question has only one correct answer.** In case you wish to change an answer, erase the old answer completely using a good soft eraser.
4. There will be **NEGATIVE** marking. In Q.1 to Q.30, **0.25** mark will be deducted for each wrong answer and in Q.31 to Q.80, **0.5** mark will be deducted for each wrong answer. In Q.81 to Q.85, for the part "a", **0.5** mark will be deducted for a wrong answer. Marks for correct answers to part "b" of Q.81 to Q.85 will be given only if the answer to the corresponding part "a" is correct. However, there is no negative marking for part "b" of Q. 81 to Q.85. More than one answer bubbled against a question will be deemed as an incorrect response.
5. Write your registration number, name and name of the Centre at the specified locations on the right half of the **ORS**.
6. Using **HB** pencil, darken the appropriate bubble under each digit of your registration number and the letters corresponding to your paper code.
7. Calculator is allowed in the examination hall.
8. Charts, graph sheets or tables are not allowed.
9. Use the blank pages given at the end of the question paper for rough work.
10. This question paper contains **20** printed pages including pages for rough work. Please check all pages and report, if there is any discrepancy.

Some useful physical constants:

1. Speed of light in free space	$c =$	$3.00 \times 10^8 \text{ m s}^{-1}$
2. Planck's constant	$h =$	$6.63 \times 10^{-34} \text{ J s}$
3. Boltzmann constant	$k =$	$1.38 \times 10^{-23} \text{ J K}^{-1}$
	or $k =$	$8.62 \times 10^{-5} \text{ eV K}^{-1}$
4. Avogadro's number	$N_A =$	$6.02 \times 10^{23} \text{ mole}^{-1}$
5. Charge of electron	$e =$	$1.60 \times 10^{-19} \text{ C}$
6. Rest mass of electron	$m =$	$9.11 \times 10^{-31} \text{ kg}$
7. Atomic mass unit (amu)	$u =$	$1.66 \times 10^{-27} \text{ kg}$

Q. 1 – Q. 30 carry one mark each

- Q.1 The average value of the function $f(x) = 4x^3$ in the interval 1 to 3 is
 (A) 15 (B) 20 (C) 40 (D) 80
- Q.2 The unit normal to the curve $x^3y^2 + xy = 17$ at the point (2,0) is
 (A) $(\hat{i} + \hat{j})/\sqrt{2}$ (B) $-\hat{i}$ (C) $-\hat{j}$ (D) \hat{j}
- Q.3 The value of the integral $\int_C \frac{dz}{z+3}$ where C is a circle (anticlockwise) with $|z| = 4$, is
 (A) 0 (B) πi (C) $2\pi i$ (D) $4\pi i$
- Q.4 The determinant of a 3x3 real symmetric matrix is 36. If two of its eigenvalues are 2 and 3 then the third eigenvalue is
 (A) 4 (B) 6 (C) 8 (D) 9
- Q.5 For a particle moving in a central field
 (A) the kinetic energy is a constant of motion
 (B) the potential energy is velocity dependent
 (C) the motion is confined in a plane
 (D) the total energy is not conserved
- Q.6 A bead of mass m slides along a straight frictionless rigid wire rotating in a horizontal plane with a constant angular speed ω . The axis of rotation is perpendicular to the wire and passes through one end of the wire. If r is the distance of the mass from the axis of rotation and v is its speed then the magnitude of the Coriolis force is
 (A) $\frac{mv^2}{r}$ (B) $\frac{2mv^2}{r}$ (C) $mv\omega$ (D) $2mv\omega$

- Q.7 If for a system of N particles of different masses m_1, m_2, \dots, m_N with position vectors $\vec{r}_1, \vec{r}_2, \dots, \vec{r}_N$ and corresponding velocities $\vec{v}_1, \vec{v}_2, \dots, \vec{v}_N$, respectively, such that $\sum \vec{v}_i = 0$, then
- (A) the total momentum MUST be zero
 (B) the total angular momentum MUST be independent of the choice of the origin
 (C) the total force on the system MUST be zero
 (D) the total torque on the system MUST be zero
- Q.8 Although mass-energy equivalence of special relativity allows conversion of a photon to an electron-positron pair, such a process cannot occur in free space because
- (A) the mass is not conserved (B) the energy is not conserved
 (C) the momentum is not conserved (D) the charge is not conserved
- Q.9 Three infinitely long wires are placed equally apart on the circumference of a circle of radius a , perpendicular to its plane. Two of the wires carry current I each, in the same direction, while the third carries current $2I$ along the direction opposite to the other two. The magnitude of the magnetic induction \vec{B} at a distance r from the centre of the circle, for $r > a$, is
- (A) 0 (B) $\frac{2\mu_0 I}{\pi r}$
 (C) $-\frac{2\mu_0 I}{\pi r}$ (D) $\frac{2\mu_0 I a}{\pi r^2}$
- Q.10 A solid sphere of radius R carries a uniform volume charge density ρ . The magnitude of electric field inside the sphere at a distance r from the centre is
- (A) $\frac{r\rho}{3\epsilon_0}$ (B) $\frac{R\rho}{3\epsilon_0}$ (C) $\frac{R^2\rho}{r\epsilon_0}$ (D) $\frac{R^3\rho}{r^2\epsilon_0}$
- Q.11 The electric field $\vec{E}(\vec{r}, t)$ for a circularly polarized electromagnetic wave propagating along the positive z direction is
- (A) $E_0(\hat{x} + \hat{y}) \exp[i(kz - \omega t)]$ (B) $E_0(\hat{x} + i\hat{y}) \exp[i(kz - \omega t)]$
 (C) $E_0(\hat{x} + i\hat{y}) \exp[i(kz + \omega t)]$ (D) $E_0(\hat{x} + \hat{y}) \exp[i(kz + \omega t)]$
- Q.12 The electric (E) and magnetic (B) field amplitudes associated with an electromagnetic radiation from a point source behave at a distance r from the source as
- (A) $E = \text{constant}, B = \text{constant}$ (B) $E \propto \frac{1}{r}, B \propto \frac{1}{r}$
 (C) $E \propto \frac{1}{r^2}, B \propto \frac{1}{r^2}$ (D) $E \propto \frac{1}{r^3}, B \propto \frac{1}{r^3}$

- Q.13 The parities of the wavefunctions (i) $\cos(kx)$ and (ii) $\tanh(kx)$ are
 (A) (i) odd, (ii) odd (B) (i) even, (ii) even
 (C) (i) odd, (ii) even (D) (i) even, (ii) odd
- Q.14 The commutator, $[L_z, Y_{lm}(\theta, \phi)]$ where L_z is the z component of the orbital angular momentum and $Y_{lm}(\theta, \phi)$ is a spherical harmonic, is
 (A) $l(l+1)\hbar$ (B) $-m\hbar$ (C) $m\hbar$ (D) $l\hbar$
- Q.15 A system in a normalized state $|\psi\rangle = c_1|\alpha_1\rangle + c_2|\alpha_2\rangle$, with $|\alpha_1\rangle$ and $|\alpha_2\rangle$ representing two different eigenstates of the system, requires that the constants c_1 and c_2 must satisfy the condition
 (A) $|c_1| \cdot |c_2| = 1$ (B) $|c_1| + |c_2| = 1$
 (C) $(|c_1| + |c_2|)^2 = 1$ (D) $|c_1|^2 + |c_2|^2 = 1$
- Q.16 A one dimensional harmonic oscillator carrying a charge $-q$ is placed in a uniform electric field \vec{E} along the positive x -axis. The corresponding Hamiltonian operator is
 (A) $\frac{\hbar^2}{2m} \frac{d^2}{dx^2} + \frac{1}{2} kx^2 + qE x$ (B) $\frac{\hbar^2}{2m} \frac{d^2}{dx^2} + \frac{1}{2} kx^2 - qE x$
 (C) $-\frac{\hbar^2}{2m} \frac{d^2}{dx^2} + \frac{1}{2} kx^2 + qE x$ (D) $-\frac{\hbar^2}{2m} \frac{d^2}{dx^2} + \frac{1}{2} kx^2 - qE x$
- Q.17 The L_β line of X-rays emitted from an atom with principal quantum numbers $n = 1, 2, 3, \dots$, arises from the transition
 (A) $n = 4 \rightarrow n = 2$ (B) $n = 3 \rightarrow n = 2$
 (C) $n = 5 \rightarrow n = 2$ (D) $n = 3 \rightarrow n = 1$
- Q.18 For an electron in hydrogen atom the states are characterized by the usual quantum numbers n, l, m_l . The electric dipole transition between any two states requires that
 (A) $\Delta l = 0, \Delta m_l = 0, \pm 1$ (B) $\Delta l = \pm 1, \Delta m_l = \pm 1, \pm 2$
 (C) $\Delta l = \pm 1, \Delta m_l = 0, \pm 1$ (D) $\Delta l = \pm 1, \Delta m_l = 0, \pm 2$
- Q.19 If the equation of state for a gas with internal energy U is $pV = \frac{1}{3}U$, then the equation for an adiabatic process is
 (A) $pV^{1/3} = \text{constant}$ (B) $pV^{2/3} = \text{constant}$
 (C) $pV^{3/5} = \text{constant}$ (D) $pV^{5/3} = \text{constant}$

- Q.20 The total number of accessible states of N noninteracting particles of spin $1/2$ is
 (A) 2^N (B) N^2 (C) $2^{N/2}$ (D) N

- Q.21 The pressure for a noninteracting Fermi gas with internal energy U at temperature T is
 (A) $p = \frac{3U}{2V}$ (B) $p = \frac{2U}{3V}$ (C) $p = \frac{3U}{5V}$ (D) $p = \frac{1U}{2V}$

- Q.22 A system of noninteracting Fermi particles with Fermi energy E_F has the density of states proportional to \sqrt{E} , where E is the energy of a particle. The average energy per particle at temperature $T = 0$ is
 (A) $\frac{1}{6}E_F$ (B) $\frac{1}{5}E_F$ (C) $\frac{2}{5}E_F$ (D) $\frac{3}{5}E_F$

- Q.23 In crystallographic notations the vector \overline{OP} in the cubic cell shown in the figure is

- (A) [221]
 (B) [122]
 (C) [121]
 (D) [112]

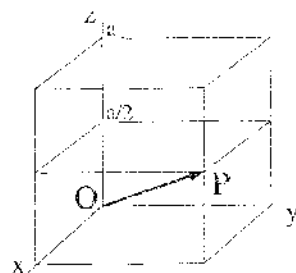

- Q.24 Match the following and choose the correct combination

Group 1 Characteristics	Group 2 Element
P. Atomic configuration $1s^2 2s^2 2p^6 3s^2 3p^6$	1. Na
Q. Strongly electropositive	2. Si
R. Strongly electronegative	3. Ar
S. Covalent bonding	4. Cl

- (A) P-1, Q-2, R-3, S-4 (B) P-3, Q-2, R-4, S-1
 (C) P-3, Q-1, R-4, S-2 (D) P-3, Q-4, R-1, S-2

- Q.25 The evidence for the nonconservation of parity in β decay has been obtained from the observation that the β intensity

- (A) antiparallel to the nuclear spin directions is same as that along the nuclear spin direction
 (B) antiparallel to the nuclear spin direction is not the same as that along the nuclear spin direction
 (C) shows a continuous distribution as a function of momentum
 (D) is independent of the nuclear spin direction

Q.26 Which of the following expressions for total binding energy B of a nucleus is correct ($a_1, a_2, a_3, a_4 > 0$)?

(A) $B = a_1 A - a_2 A^{2/3} - a_3 \frac{Z(Z-1)}{A^{1/3}} - a_4 \frac{(A-2Z)^2}{A} + \delta$

(B) $B = a_1 A + a_2 A^{2/3} - a_3 \frac{Z(Z-1)}{A^{1/3}} - a_4 \frac{(A-2Z)^2}{A} + \delta$

(C) $B = a_1 A + a_2 A^{1/3} - a_3 \frac{Z(Z-1)}{A^{1/3}} - a_4 \frac{(A-2Z)^2}{A} + \delta$

(D) $B = a_1 A - a_2 A^{1/3} - a_3 \frac{Z(Z-1)}{A^{1/3}} - a_4 \frac{(A-2Z)^2}{A} + \delta$

Q.27 Which of the following decay is forbidden?

(A) $\mu^- \rightarrow e^- + \nu_\mu + \bar{\nu}_e$

(B) $\pi^+ \rightarrow \mu^+ + \nu_\mu$

(C) $\pi^+ \rightarrow e^+ + \nu_e$

(D) $\mu^- \rightarrow e^+ + e^- + e^-$

Q.28 With reference to nuclear forces which of the following statements is NOT true?
The nuclear forces are

- (A) short range
- (B) charge independent
- (C) velocity dependent
- (D) spin independent

Q.29 A junction field effect transistor behaves as a

- (A) voltage controlled current source
- (B) voltage controlled voltage source
- (C) current controlled voltage source
- (D) current controlled current source

Q.30 The circuit shown can be used as

- (A) NOR gate
- (B) OR gate
- (C) NAND gate
- (D) AND gate

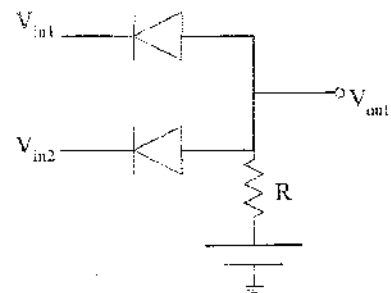

Q. 31 to Q. 80 carry two marks each

Q.31 If a vector field $\vec{F} = x\hat{i} + 2y\hat{j} + 3z\hat{k}$, then $\vec{\nabla} \times (\vec{\nabla} \times \vec{F})$ is

- (A) 0 (B) \hat{i} (C) $2\hat{j}$ (D) $3\hat{k}$

Q.32 All solutions of the equation $e^z = -3$ are

- (A) $z = i n \pi \ln 3, n = \pm 1, \pm 2, \dots$
 (B) $z = \ln 3 + i(2n+1)\pi, n = 0, \pm 1, \pm 2, \dots$
 (C) $z = \ln 3 + i 2n\pi, n = 0, \pm 1, \pm 2, \dots$
 (D) $z = i 3n\pi, n = \pm 1, \pm 2, \dots$

Q.33 If $\bar{f}(s)$ is the Laplace transform of $f(t)$ the Laplace transform of $f(at)$, where a is a constant, is

- (A) $\frac{1}{a} \bar{f}(s)$ (B) $\frac{1}{a} \bar{f}(s/a)$ (C) $\bar{f}(s)$ (D) $\bar{f}(s/a)$

Q.34 Given the four vectors

$$u_1 = \begin{pmatrix} 1 \\ 2 \\ 1 \end{pmatrix}, u_2 = \begin{pmatrix} 3 \\ -5 \\ 1 \end{pmatrix}, u_3 = \begin{pmatrix} 2 \\ 4 \\ -8 \end{pmatrix}, u_4 = \begin{pmatrix} 3 \\ 6 \\ -12 \end{pmatrix}.$$

the linearly dependent pair is

- (A) u_1, u_2 (B) u_1, u_3 (C) u_1, u_4 (D) u_3, u_4

Q.35 Which of the following functions of the complex variable z is NOT analytic everywhere?

- (A) e^z (B) $\sin z / z$ (C) z^3 (D) $|z|^3$

Q.36 Eigenvalues of the matrix

$$\begin{pmatrix} 0 & 1 & 0 & 0 \\ 1 & 0 & 0 & 0 \\ 0 & 0 & 0 & -2i \\ 0 & 0 & 2i & 0 \end{pmatrix}$$

are

- (A) -2, -1, 1, 2
 (B) -1, 1, 0, 2
 (C) 1, 0, 2, 3
 (D) -1, 1, 0, 3

- Q.37 If a particle moves outward in a plane along a curved trajectory described by $r = a\theta$, $\theta = \omega t$, where a and ω are constants, then its
- (A) kinetic energy is conserved (B) angular momentum is conserved
(C) total momentum is conserved (D) radial momentum is conserved
- Q.38 A circular hoop of mass M and radius a rolls without slipping with constant angular speed ω along the horizontal x -axis in the x - y plane. When the centre of the hoop is at a distance $d = \sqrt{2}a$ from the origin, the magnitude of the total angular momentum of the hoop about the origin is
- (A) $Ma^2\omega$ (B) $\sqrt{2}Ma^2\omega$ (C) $2Ma^2\omega$ (D) $3Ma^2\omega$
- Q.39 Two solid spheres of radius R and mass M each are connected by a thin rigid rod of negligible mass. The distance between the centres is $4R$. The moment of inertia about an axis passing through the centre of symmetry and perpendicular to the line joining the spheres is
- (A) $\frac{11}{5}MR^2$ (B) $\frac{22}{5}MR^2$ (C) $\frac{44}{5}MR^2$ (D) $\frac{88}{5}MR^2$
- Q.40 A car is moving with constant linear acceleration a along horizontal x -axis. A solid sphere of mass M and radius R is found rolling without slipping on the horizontal floor of the car in the same direction as seen from an inertial frame outside the car. The acceleration of the sphere in the inertial frame is
- (A) $\frac{a}{7}$ (B) $\frac{2a}{7}$ (C) $\frac{3a}{7}$ (D) $\frac{5a}{7}$
- Q.41 A rod of length l_0 makes an angle θ_0 with the y -axis in its rest frame, while the rest frame moves to the right along the x -axis with relativistic speed v with respect to the lab frame. If $\gamma = (1 - v^2/c^2)^{-1/2}$, the angle θ in the lab frame is
- (A) $\theta = \tan^{-1}(\gamma \tan \theta_0)$ (B) $\theta = \tan^{-1}(\gamma \cot \theta_0)$
(C) $\theta = \tan^{-1}(\frac{1}{\gamma} \tan \theta_0)$ (D) $\theta = \tan^{-1}(\frac{1}{\gamma} \cot \theta_0)$
- Q.42 A particle of mass m moves in a potential $V(x) = \frac{1}{2}m\omega^2x^2 + \frac{1}{2}m\mu v^2$ where x is the position coordinate, v is the speed, and ω and μ are constants. The canonical (conjugate) momentum of the particle is
- (A) $p = m(1 + \mu)v$ (B) $p = mv$
(C) $p = m\mu v$ (D) $p = m(1 - \mu)v$

- Q.43 Consider the following three independent cases:
- Particle A of charge $+q$ moves in free space with a constant velocity \vec{v} ($v \ll$ speed of light)
 - Particle B of charge $+q$ moves in free space in a circle of radius R with same speed v as in case (i)
 - Particle C having charge $-q$ moves as in case (ii)
- If the powers radiated by A, B, and C are P_A , P_B , and P_C , respectively, then

- (A) $P_A = 0$, $P_B > P_C$ (B) $P_A = 0$, $P_B = P_C$
 (C) $P_A > P_B > P_C$ (D) $P_A = P_B = P_C$

- Q.44 If the electrostatic potential were given by $\phi = \phi_0(x^2 + y^2 + z^2)$, where ϕ_0 is constant, then the charge density giving rise to the above potential would be

- (A) 0 (B) $-6\phi_0 \epsilon_0$ (C) $-2\phi_0 \epsilon_0$ (D) $-\frac{6\phi_0}{\epsilon_0}$

- Q.45 The work done in bringing a charge $+q$ from infinity in free space, to a position at a distance d in front of a semi-infinite grounded metal surface is

- (A) $-\frac{q^2}{4\pi\epsilon_0(d)}$ (B) $-\frac{q^2}{4\pi\epsilon_0(2d)}$
 (C) $-\frac{q^2}{4\pi\epsilon_0(4d)}$ (D) $-\frac{q^2}{4\pi\epsilon_0(6d)}$

- Q.46 A plane electromagnetic wave traveling in vacuum is incident normally on a non-magnetic, non-absorbing medium of refractive index n . The incident (E_i), reflected (E_r) and transmitted (E_t) electric fields are given as,

$$E_i = E_{0i} \exp[i(kz - \omega t)], \quad E_r = E_{0r} \exp[i(k_r z - \omega t)], \quad E_t = E_{0t} \exp[i(k_t z - \omega t)].$$

If $E_{0i} = 2$ V/m and $n = 1.5$ then the application of appropriate boundary conditions leads to

- (A) $E_{0r} = -\frac{3}{5}$ V/m, $E_{0t} = \frac{7}{5}$ V/m (B) $E_{0r} = -\frac{1}{5}$ V/m, $E_{0t} = \frac{9}{5}$ V/m
 (C) $E_{0r} = -\frac{2}{5}$ V/m, $E_{0t} = \frac{8}{5}$ V/m (D) $E_{0r} = \frac{4}{5}$ V/m, $E_{0t} = \frac{6}{5}$ V/m

- Q.47 For a vector potential \vec{A} , the divergence of \vec{A} is $\vec{\nabla} \cdot \vec{A} = -\frac{\mu_0 Q}{4\pi r^2}$, where Q is a constant of appropriate dimension. The corresponding scalar potential $\phi(\vec{r}, t)$ that makes \vec{A} and ϕ Lorentz gauge invariant is

- (A) $\frac{1}{4\pi\epsilon_0} \frac{Q}{r}$ (B) $\frac{1}{4\pi\epsilon_0} \frac{Qt}{r}$ (C) $\frac{1}{4\pi\epsilon_0} \frac{Q}{r^2}$ (D) $\frac{1}{4\pi\epsilon_0} \frac{Qt}{r^2}$

- Q.48 An infinitely long wire carrying a current $I(t) = I_0 \cos(\omega t)$ is placed at a distance a from a square loop of side a as shown in the figure. If the resistance of the loop is R , then the amplitude of the induced current in the loop is

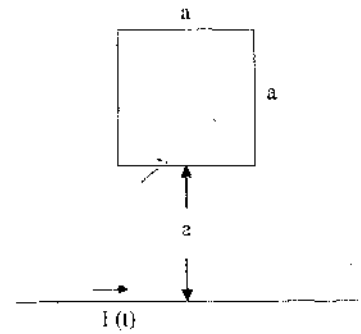

- (A) $\frac{\mu_0 a I_0 \omega}{2\pi R} \ln 2$
 (B) $\frac{\mu_0 a I_0 \omega}{\pi R} \ln 2$
 (C) $\frac{2\mu_0 a I_0 \omega}{\pi R} \ln 2$
 (D) $\frac{\mu_0 a I_0 \omega}{2\pi R}$

- Q.49 The de Broglie wavelength λ for an electron of energy 150 eV is

- (A) 10^{-8} m (B) 10^{-10} m (C) 10^{-12} m (D) 10^{-14} m

- Q.50 A particle is incident with a constant energy E on a one-dimensional potential barrier as shown in the figure. The wavefunctions in regions I and II are respectively

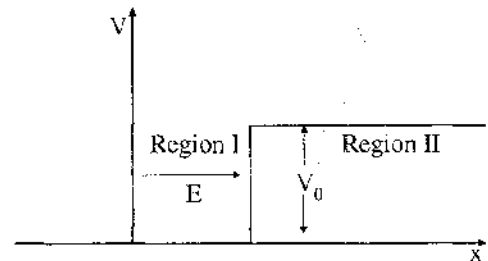

- (A) decaying, oscillatory
 (B) oscillatory, oscillatory
 (C) oscillatory, decaying
 (D) decaying, decaying

- Q.51 The expectation value of the z coordinate, $\langle z \rangle$, in the ground state of the hydrogen atom (wavefunction: $\psi_{100}(r) = A e^{-r/a_0}$, where A is the normalization constant and a_0 is the Bohr radius), is

- (A) a_0 (B) $\frac{a_0}{2}$ (C) $\frac{a_0}{4}$ (D) 0

- Q.52 The degeneracy of the $n = 2$ level for a three dimensional isotropic oscillator is

- (A) 4 (B) 6 (C) 8 (D) 10

- Q.53 For a spin $1/2$ particle, the expectation value of $s_x s_y s_z$, where s_x , s_y and s_z are spin operators, is

- (A) $\frac{i \hbar^3}{8}$ (B) $-\frac{i \hbar^3}{8}$ (C) $\frac{i \hbar^3}{16}$ (D) $-\frac{i \hbar^3}{16}$

- Q.54 An atom emits a photon of wavelength $\lambda = 600 \text{ nm}$ by transition from an excited state of lifetime $8 \times 10^{-9} \text{ s}$. If $\Delta\nu$ represents the minimum uncertainty in the frequency of the photon, the fractional width $\frac{\Delta\nu}{\nu}$ of the spectral line is of the order of
- (A) 10^{-4} (B) 10^{-6} (C) 10^{-8} (D) 10^{-10}
- Q.55 The sodium doublet lines are due to transitions from $^2P_{3/2}$ and $^2P_{1/2}$ levels to $^2S_{1/2}$ level. On application of a weak magnetic field, the total number of allowed transitions becomes
- (A) 4 (B) 6 (C) 8 (D) 10
- Q.56 A three level system of atoms has N_1 atoms in level E_1 , N_2 in level E_2 , and N_3 in level E_3 ($N_2 > N_1 > N_3$, and $E_1 < E_2 < E_3$). Laser emission is possible between the levels
- (A) $E_3 \rightarrow E_1$ (B) $E_2 \rightarrow E_1$ (C) $E_3 \rightarrow E_2$ (D) $E_2 \rightarrow E_3$
- Q.57 In a Raman scattering experiment, light of frequency ν from a laser is scattered by diatomic molecules having the moment of inertia I . The typical Raman shifted frequency depends on
- (A) ν and I (B) only ν
 (C) only I (D) neither ν nor I
- Q.58 For a diatomic molecule with the vibrational quantum number n and rotational quantum number J , the vibrational level spacing $\Delta E_n = E_n - E_{n-1}$ and the rotational level spacing $\Delta E_J = E_J - E_{J-1}$ are approximately
- (A) $\Delta E_n = \text{constant}$, $\Delta E_J = \text{constant}$ (B) $\Delta E_n = \text{constant}$, $\Delta E_J \propto J$
 (C) $\Delta E_n \propto n$, $\Delta E_J \propto J$ (D) $\Delta E_n \propto n$, $\Delta E_J \propto J^2$
- Q.59 The typical wavelengths emitted by diatomic molecules in purely vibrational and purely rotational transitions are *respectively* in the region of
- (A) infrared and visible (B) visible and infrared
 (C) infrared and microwave (D) microwave and infrared
- Q.60 In a two electron atomic system having orbital and spin angular momenta l_1, l_2 and s_1, s_2 respectively, the coupling strengths are defined as $\Gamma_{l_1 l_2}$, $\Gamma_{s_1 s_2}$, $\Gamma_{l_1 s_1}$, $\Gamma_{l_2 s_2}$, $\Gamma_{l_1 s_2}$ and $\Gamma_{l_2 s_1}$. For the *jj* coupling scheme to be applicable, the coupling strengths MUST satisfy the condition
- (A) $\Gamma_{l_1 l_2}, \Gamma_{s_1 s_2} > \Gamma_{l_1 s_1}, \Gamma_{l_2 s_2}$ (B) $\Gamma_{l_1 s_1}, \Gamma_{l_2 s_2} > \Gamma_{l_1 l_2}, \Gamma_{s_1 s_2}$
 (C) $\Gamma_{l_1 s_2}, \Gamma_{l_2 s_1} > \Gamma_{l_1 l_2}, \Gamma_{s_1 s_2}$ (D) $\Gamma_{l_1 s_2}, \Gamma_{l_2 s_1} > \Gamma_{l_1 s_1}, \Gamma_{l_2 s_2}$

Q.61 If the probability that x lies between x and $x+dx$ is $p(x)dx = ae^{-ax}dx$, where $0 < x < \infty$, $a > 0$, then the probability that x lies between x_1 and x_2 ($x_2 > x_1$) is

- (A) $(e^{-ax_1} - e^{-ax_2})$ (B) $a(e^{-ax_1} - e^{-ax_2})$
 (C) $e^{-ax_2}(e^{-ax_1} - e^{-ax_2})$ (D) $e^{-ax_1}(e^{-ax_1} - e^{-ax_2})$

Q.62 If the partition function of a harmonic oscillator with frequency ω at a temperature T is $\frac{kT}{\hbar\omega}$, then the free energy of N such independent oscillators is

- (A) $\frac{3}{2}NkT$ (B) $kT \ln \frac{\hbar\omega}{kT}$ (C) $NkT \ln \frac{\hbar\omega}{kT}$ (D) $NkT \ln \frac{\hbar\omega}{2kT}$

Q.63 The partition function of two Bose particles each of which can occupy any of the two energy levels 0 and ϵ is

- (A) $1 + e^{-\epsilon/kT} + 2e^{-\epsilon/kT}$ (B) $1 + e^{-\epsilon/kT} + e^{-\epsilon/kT}$
 (C) $2 + e^{-\epsilon/kT} + e^{-\epsilon/kT}$ (D) $e^{-\epsilon/kT} + e^{-\epsilon/kT}$

Q.64 A one dimensional random walker takes steps to left or right with equal probability. The probability that the random walker starting from origin is back to origin after N even number of steps is

- (A) $\frac{N!}{\left(\frac{N}{2}\right)! \left(\frac{N}{2}\right)!} \left(\frac{1}{2}\right)^N$ (B) $\frac{N!}{\left(\frac{N}{2}\right)! \left(\frac{N}{2}\right)!}$
 (C) $2^{-N} N! \left(\frac{1}{2}\right)^{2N}$ (D) $N! \left(\frac{1}{2}\right)^N$

Q.65 The number of states for a system of N identical free particles in a three dimensional space having total energy between E and $E + \delta E$ ($\delta E \ll E$), is proportional to

- (A) $\left(E^{\frac{3N}{2}-1}\right) \delta E$ (B) $E^{\frac{N}{2}} \delta E$
 (C) $NE^{\frac{1}{2}} \delta E$ (D) $E^N \delta E$

Q.66 The energy of a ferromagnet as a function of magnetization M is given by

$$F(M) = F_0 + 2(T - T_c)M^2 + M^4, \quad F_0 > 0.$$

The number of minima in the function $F(M)$ for $T > T_c$ is

- (A) 0 (B) 1 (C) 3 (D) 4

- Q.67 For a closed packed BCC structure of hard spheres, the lattice constant a is related to the sphere radius R as
- (A) $a = 4R/\sqrt{3}$ (B) $a = 4R\sqrt{3}$ (C) $a = 4R\sqrt{2}$ (D) $a = 2R\sqrt{2}$
- Q.68 An n-type semiconductor has an electron concentration of $3 \times 10^{20} \text{ m}^{-3}$. If the electron drift velocity is 100 ms^{-1} in an electric field of 200 Vm^{-1} , the conductivity (in $\Omega^{-1} \text{ m}^{-1}$) of this material is
- (A) 24 (B) 36 (C) 48 (D) 96
- Q.69 Density of states of free electrons in a solid moving with an energy 0.1 eV is given by $2.15 \times 10^{21} \text{ eV}^{-1} \text{ cm}^{-3}$. The density of states (in $\text{eV}^{-1} \text{ cm}^{-3}$) for electrons moving with an energy of 0.4 eV will be
- (A) 1.07×10^{21} (B) 1.52×10^{21} (C) 3.04×10^{21} (D) 4.30×10^{21}
- Q.70 The effective density of states at the conduction band edge of Ge is $1.04 \times 10^{19} \text{ cm}^{-3}$ at room temperature (300K). Ge has an optical bandgap of 0.66eV. The intrinsic carrier concentration (in cm^{-3}) in Ge at room temperature (300 K) is approximately
- (A) 3×10^{10} (B) 3×10^{13} (C) 3×10^{16} (D) 6×10^{16}
- Q.71 For a conventional superconductor, which of the following statements is NOT true?
- (A) Specific heat is discontinuous at transition temperature T_c
 (B) The resistivity falls sharply at T_c
 (C) It is diamagnetic below T_c
 (D) It is paramagnetic below T_c
- Q.72 A nucleus having mass number 240 decays by α emission to the ground state of its daughter nucleus. The Q value of the process is 5.26 MeV. The energy (in MeV) of the α particle is
- (A) 5.26 (B) 5.17 (C) 5.13 (D) 5.09
- Q.73 The threshold temperature above which the thermonuclear reaction
 ${}^3_2\text{He} + {}^3_2\text{He} \rightarrow {}^4_2\text{He} + 2{}^1_1\text{H} + 12.86 \text{ MeV}$
 can occur is (use $e^2/4\pi\epsilon_0 = 1.44 \times 10^{-15} \text{ MeVm}$)
- (A) $1.28 \times 10^{10} \text{ K}$ (B) $1.28 \times 10^9 \text{ K}$ (C) $1.28 \times 10^8 \text{ K}$ (D) $1.28 \times 10^7 \text{ K}$
- Q.74 According to the shell model, the ground state of ${}^{15}_8\text{O}$ nucleus is
- (A) $\frac{3}{2}^-$ (B) $\frac{1}{2}^+$ (C) $\frac{3}{2}^-$ (D) $\frac{1}{2}^-$

Q.75 The plot of $\log A$ vs. time t , where A is activity, as shown in the figure, corresponds to decay

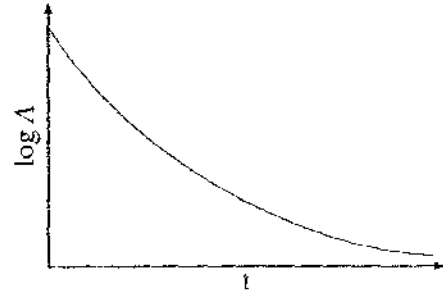

- (A) from only one kind of radioactive nuclei having same half life
- (B) from only neutron activated nuclei
- (C) from a mixture of radioactive nuclei having different half lives
- (D) which is unphysical

Q.76 For the rectifier circuit shown in the figure, the sinusoidal voltage (V_1 or V_2) at the output of the transformer has a maximum value of 10 V. The load resistance R_L is 1 k Ω . If I_{av} is the average current through the resistor R_L the circuit corresponds to a

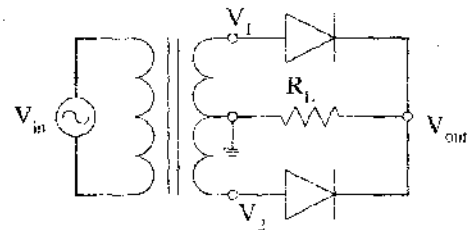

- (A) full wave rectifier with $I_{av} = 20/\pi$ mA
- (B) half wave rectifier with $I_{av} = 20/\pi$ mA
- (C) half wave rectifier with $I_{av} = 10/\pi$ mA
- (D) full wave rectifier with $I_{av} = 10/\pi$ mA

Q.77 The Boolean expression: $B \cdot (A + B) + A \cdot (\bar{B} + A)$ can be realized using minimum number of

- (A) 1 AND gate
- (B) 2 AND gates
- (C) 1 OR gate
- (D) 2 OR gates

Q.78 The output V_o of the ideal op-amp circuit shown in the figure is

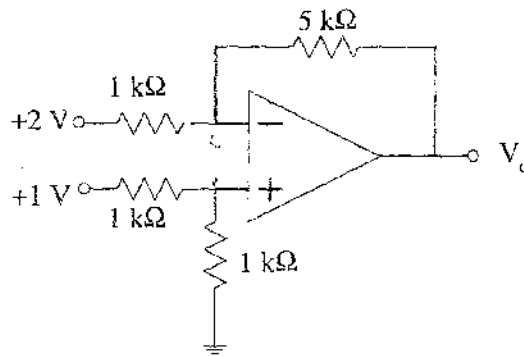

- (A) -7 V
- (B) -5 V
- (C) 5 V
- (D) 7 V

Q.79 The circuit shown in the figure can be used as a

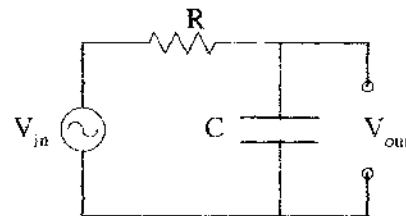

- (A) high pass filter or a differentiator
- (B) high pass filter or an integrator
- (C) low pass filter or a differentiator
- (D) low pass filter or an integrator

- Q.80 In the circuit shown in the figure the Thevenin voltage V_{Th} and Thevenin resistance R_{Th} as seen by the load resistance $R_L (=1 \text{ k}\Omega)$ are respectively

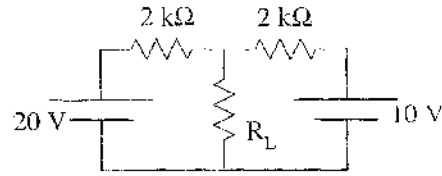

- (A) 15 V, 1 k Ω
 (B) 30 V, 4 k Ω
 (C) 20 V, 2 k Ω
 (D) 10 V, 5 k Ω

Linked Answer Questions: Q.81a to Q.85b carry two marks each

Statement for Linked Answer Questions 81a & 82b:

For the differential equation $\frac{d^2 y}{dx^2} - 2 \frac{dy}{dx} + y = 0$

- Q.81a One of the solutions is

- (A) e^x (B) $\ln x$ (C) e^{-x^2} (D) e^{x^2}

- Q.81b The second linearly independent solution is

- (A) e^{-x} (B) xe^x (C) $x^2 e^x$ (D) $x^2 e^{-x}$

Statement for Linked Answer Questions 82a & 82b:

The Lagrangian of two coupled oscillators of mass m each is

$$L = \frac{1}{2} m (\dot{x}_1^2 + \dot{x}_2^2) - \frac{1}{2} m \omega_0^2 (x_1^2 + x_2^2) + m \omega_0^2 \mu x_1 x_2$$

- Q.82a The equations of motion are

- (A) $\ddot{x}_1 + \omega_0^2 x_1 = \omega_0^2 \mu x_1$, $\ddot{x}_2 + \omega_0^2 x_2 = \omega_0^2 \mu x_2$
 (B) $\ddot{x}_1 + \omega_0^2 x_1 = \omega_0^2 \mu x_2$, $\ddot{x}_2 + \omega_0^2 x_2 = \omega_0^2 \mu x_1$
 (C) $\ddot{x}_1 + \omega_0^2 x_1 = \omega_0^2 \mu x_1$, $\ddot{x}_2 + \omega_0^2 x_2 = -\omega_0^2 \mu x_2$
 (D) $\ddot{x}_1 + \omega_0^2 x_1 = \omega_0^2 \mu x_1$, $\ddot{x}_2 + \omega_0^2 x_2 = \omega_0^2 \mu x_1$

- Q.82b The normal modes of the system are

- (A) $\omega_0 \sqrt{\mu^2 - 1}$, $\omega_0 \sqrt{\mu^2 + 1}$ (B) $\omega_0 \sqrt{1 - \mu^2}$, $\omega_0 \sqrt{1 + \mu^2}$
 (C) $\omega_0 \sqrt{\mu - 1}$, $\omega_0 \sqrt{\mu + 1}$ (D) $\omega_0 \sqrt{1 - \mu}$, $\omega_0 \sqrt{1 + \mu}$

Statement for Linked Answer Questions 83a & 83 b:

An infinitely long hollow cylinder of radius R carrying a surface charge density σ is rotated about its cylindrical axis with a constant angular speed ω .

Q.83a The magnitude of the surface current is

- (A) $\sigma R \omega$ (B) $2 \sigma R \omega$
(C) $\pi \sigma R \omega$ (D) $2 \pi \sigma R \omega$

Q.83b The magnitude of vector potential inside the cylinder at a distance r from its axis is

- (A) $2 \mu_0 \sigma R \omega r$ (B) $\mu_0 \sigma R \omega r$
(C) $\frac{1}{2} \mu_0 \sigma R \omega r$ (D) $\frac{1}{4} \mu_0 \sigma R \omega r$

Statement for Linked Answer Questions 84a & 84b:

A particle is scattered by a spherically symmetric potential. In the centre of mass (CM) frame the wavefunction of the incoming particle is $\psi = A e^{ikz}$ where k is the wavevector and A is a constant.

Q.84a If $f(\theta)$ is an angular function then in the asymptotic region the scattered wavefunction has the form

- (A) $\frac{A f(\theta) e^{ikr}}{r}$ (B) $\frac{A f(\theta) e^{-ikr}}{r}$
(C) $\frac{A f(\theta) e^{ikr}}{r^2}$ (D) $\frac{A f(\theta) e^{-ikr}}{r^2}$

Q.84b The differential scattering cross section $\sigma(\theta)$ in CM frame is

- (A) $\sigma(\theta) = |A|^2 \frac{|f(\theta)|^2}{r^2}$ (B) $\sigma(\theta) = |A|^2 |f(\theta)|^2$
(C) $\sigma(\theta) = |f(\theta)|^2$ (D) $\sigma(\theta) = |A| |f(\theta)|$

Statement for Linked Answer Questions 85a & 85b:

Lead has atomic weight of 207.2 amu and density of 11.35 gm cm^{-3} .

Q.85a Number of atoms per cm^3 for lead is

- (A) 1.1×10^{25} (B) 3.3×10^{22}
(C) 1.1×10^{23} (D) 3.3×10^{25}

Q.85b If the energy of vacancy formation in lead is 0.55 eV/atom, the number of vacancies/ cm^3 at 500K is

- (A) 3.2×10^{16} (B) 3.2×10^{19}
(C) 9.5×10^{19} (D) 9.5×10^{16}

***** END OF THE QUESTION PAPER *****