

**Objective Paper-I-2011**

1. For smooth and reliable operation of an amplifier using BJT, it is necessary that the circuit must be properly designed from the point of view of bias stabilization, because:
  1. Reverse saturation current  $I_{CO}$  increases with rise in temperature.
  2.  $V_{BE}$  decreases with rise in temperature
  3.  $h_{FE}$  or  $\beta$  changes with change of temperature and replacement of the transistor
  4.  $h_{FE}$  or  $\beta$  changes with change in collector supply voltage(A) 1, 2, and 3 only (B) 1, 2, and 4 only (C) 2, 3 and 4 only (D) 1, 2, 3 and 4
2. Intense magnetic field may be produced in a coil by using a:
  - (A) Normal metal with a large number of turns and sending a large current
  - (B) Type-I superconductor with a large number of turns and sending a large current
  - (C) Type-II superconductor with a large number of turns and sending a large current
  - (D) Type-II superconductor with a large number of turns but limiting the current density below a critical value
3. The unit cell of a certain type of crystal is defined by three vectors a, b and c. The vectors are mutually perpendicular, but  $a \neq b \neq c$ . The crystal structure is:
  - (A) Triclinic
  - (B) Tetragonal
  - (C) Orthorhombic
  - (D) Monoclinic
4. Biasing is used in transition amplifiers to:
  1. Stabilize the operating point against temperature variations
  2. Place the operating point in the linear region of the characteristics.
  3. Make  $\alpha$ ,  $\beta$  and  $I_{CO}$  of the transistor independent of temperature variations.
  4. Reduce distortion and increase dynamic range(A) 1, 2, 3 and 4 (B) 1, 2 and 4 only  
(C) 1, 2 and 3 only (D) 2, 3 and 4 only
5. The resistivity of a metal is a function of temperature because:
  - (A) The electron density varies with temperature
  - (B) The electron gas density varies with temperature
  - (C) The lattices vibration increases with temperature
  - (D) Collision of electrons increases as temperature increases
6. An intrinsic semiconductor has the following properties:
  1. Its electron concentration equals its hole concentration
  2. Its carrier density increases with temperature

3. Its conductivity decreases with temperature  
(A) 1, 2 and 3      (B) 2 and 3 only      (C) 1 and 3 only      (D) 1 and 2 only
7. A 'hole' in a semiconductor has:  
1. Positive charge equal to the electron charge  
2. Positive mass equal to the mass of the electron  
3. An effective mass greater than the effective mass of electron  
4. Negative mass and positive charge equal to the charge in nucleus  
(A) 1, 2, 3 and 4      (B) 1 and 3 only      (C) 2 and 4 only      (D) 3 and 4 only
8. A CE amplifier has an un-bypassed emitter resistance of  $0.5k\Omega$  and a collector load of  $5k\Omega$ . The  $\beta$  of the transistor is 100 and it is operating at 1mA. The voltage gain of the stage at mid band will be of the order of:  
(A) 200      (B) 100      (C) 10      (D) 50
9. A common emitter transistor amplifier has a collector load of  $10k\Omega$ . If its  $h_{fe} = 100k\Omega$  and  $h_{ie} = 2k\Omega$  ( $h_{re} \approx h_{oe} \approx 0$ ), the voltage amplification of the amplifier is nearly equal to:  
(A) 500      (B) 200      (C) 100      (D) 50
10. The free electrons in a metal follow the kinetic theory of gases and the following statements are made about their properties:  
1. The velocity of all the electrons is equal.  
2. The electrons have a velocity distribution ranging from zero to infinity  
3. The average velocity of electron gas is proportional to  $\sqrt{T}$  (T = temperature)  
4. The maximum velocity of electrons is proportional to T.  
Which of these statements are correct?  
(A) 1, 2, 3 and 4      (B) 1 and 3 only      (C) 2 and 3 only      (D) 3 and 4 only
11. Using transistors:  
1. Class-A power amplifier has a minimum efficiency of 50%.  
2. Class-B push-pull power amplifier gives rise to crossover distortion.  
3. Class-AB push-pull power amplifier has higher efficiency than Class-B push-pull amplifier.  
4. Class-C power amplifier is generally used with tuned load for RF amplification.  
(A) 1, 2, 3 and 4      (B) 2 and 4 only      (C) 3 and 4 only      (D) 1 and 2 only
12. A material shows spontaneous magnetization. This is due to:  
1. Weiss molecular field  
2. Co-operative effect among dipoles  
3. Co-operative effect among domains  
4. Absence of applied magnetic field

- (A) 1, 2, 3 and 4 (B) 2, 3 and 4 only  
(C) 1, 2 and 3 only (D) 1, 2 and 4 only
13. Materials in which the permanent dipoles interact with each other so heavily that they tend to align parallel to each other are called:  
(A) Ferromagnetic (B) Ferrimagnetic  
(C) Paramagnetic (D) Anti-ferromagnetic
14. A type-I superconductor is:  
1. A conductor of infinite conductivity at all temperatures  
2. A conductor with very large conductivity below a critical temperature  
3. A material showing susceptibility=1 below critical temperature  
4. A perfect conductor having conductivity drastically reduced by a critical current  
(A) 1, 2 and 3 only (B) 2, 3 and 4 only  
(C) 1, 2 and 4 only (D) 1, 2, 3 and 4
15. In an RC coupled transistor amplifier:  
1. Low frequency response is determined by coupling capacitors  
2. High frequency response is determined by junction capacitances  
3. Mid-frequency response is determined by both coupling and junction capacitances.  
(A) 1 and 2 only (B) 1 and 3 only (C) 2 and 3 only (D) 1, 2 and 3
16. Ti is diffused into a well defined region of  $\text{LiNbO}_3$  crystal. The following effects are expected:  
1. An optical waveguide is formed in the region containing Ti.  
2. Ti containing region has a larger refractive index than in undoped region  
3. Ti containing region has a lower refractive index than in undoped region  
(A) 1, 2 and 3 (B) 1 and 3 only  
(C) 1 and 2 only (D) 2 and 3 only
17. The inductance  $L_F$  and resistance  $R_F$  in the following circuit is used for:

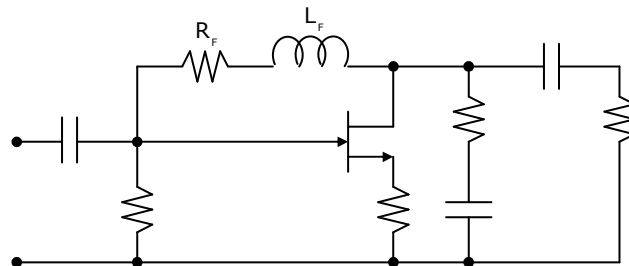

- (A) Low frequency compensation only
- (B) High frequency compensation only
- (C) Both low frequency and high frequency compensation
- (D) Increasing mid frequency gain without affecting the cut-off frequencies

18. In the following circuit, the optimum low frequency compensation is obtained when:

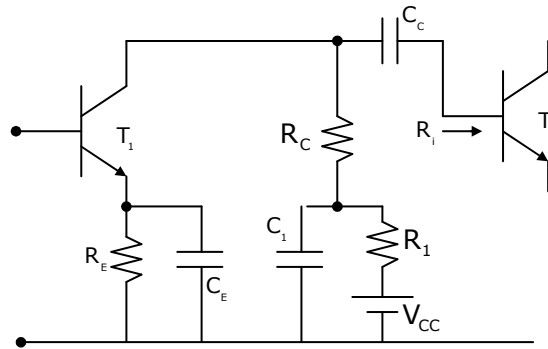

- (A)  $C_1 R_1 = R_E C_E$
- (B)  $C_1 R_1 = C_C R_i$
- (C)  $C_1 (R_C \parallel R_1) = C_C R_i$
- (D)  $C_1 (R_C \parallel R_1) = R_E C_E$

19. The amplifier circuit shown in the figure is an example of:

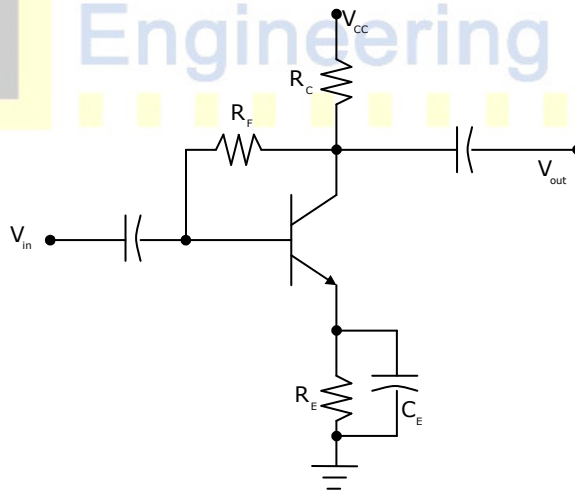

- (A) Voltage series feedback
- (B) Voltage shunt feedback
- (C) Current series feedback
- (D) Current shunt feedback

20. The peak output of a tuned amplifier is at 6MHz and has quality factor of 60. The bandwidth and 3dB frequencies in MHz shall be:

- (A) 100, 6.05 and 5.95
- (B) 6, 9 and 3
- (C) 0.6, 6.6 and 5.4
- (D) 0.1, 6.05 and 5.95

21. On applying an electric field of intensity 10V/cm across a semiconductor at a certain temperature the average drift velocity of free electrons is measured to be 70m/s. Then the electron mobility is:  
 (A)  $7 \times 10^4 \text{ cm}^2 / \text{Vs}$  (B)  $700 \text{ cm}^2 / \text{Vs}$  (C)  $7 \text{ m}^2 / \text{Vs}$  (D)  $700 \text{ cm} / \text{Vs}$
22. Consider the following statements with regard to semiconductors:  
 1. In n-type material, free electron concentration is nearly equal to density of donor atoms.  
 2. 1 part in  $10^8$  donor type impurity added to Ge improves its conductivity at  $30^\circ\text{C}$  by a factor of 12.  
 3. Phosphorous is an example of n-type impurity  
 4. Conductivity of Si is more sensitive to temperature than Ge  
 Which of these statements are correct?  
 (A) 1, 2 and 3 only (B) 1, 3 and 4 only (C) 2 and 4 only (D) 1, 2, 3 and 4
23. The diffusion constant for holes in silicon is  $13 \text{ cm}^2 / \text{s}$ . What is the diffusion current if the gradient of the hole concentration  $\frac{dP}{dX} = -2 \times 10^{14}$  holes per  $\text{cm}^3 / \text{cm}$ ?  
 (A)  $-0.416 \text{ mA}$  (B)  $-3.2 \times 10^{-5} \text{ A}$  (C)  $32 \mu\text{A}$  (D)  $0.416 \text{ mA}$
24. Given that at room temperature, the volt equivalent of temperature  $V_T = 26 \text{ mV}$ , hole mobility  $\mu_p = 500 \text{ cm}^2 / \text{Vs}$  and the life time of holes is 130ns, in a sample of n-type silicon bar that is exposed to radiation at one end at low-injection level, what is the diffusion length of holes?  
 (A) 1300 microns (B) 100 Armstrong's (C) 169 microns (D) 100 microns
25. The function  $(A \oplus B)$  is to be realized using only 2-input NAND gates. The minimum number of 2-input NAND gates required for such a realization is:  
 (A) 3 (B) 4 (C) 5 (D) 6
26. Consider a semiconductor carrying current and placed in a transverse magnetic field  $B$ , as shown below. The measured potential across 1 and 2 surfaces is positive at 2. What is the type of the material?  
 (A) Intrinsic Si material  
 (B) n-type semiconductor material  
 (C) p-type semiconductor material  
 (D) No such conclusion can be drawn

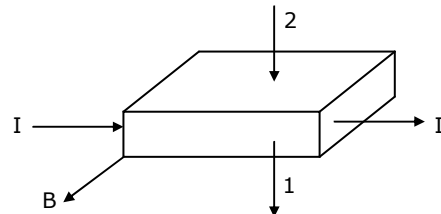

27. A 700mW maximum power dissipation diode at  $25^\circ\text{C}$  has  $5 \text{ mW}/^\circ\text{C}$  de-rating factor. If the forward voltage drop remains constant at 0.7V, the maximum forward current at  $65^\circ\text{C}$  is:  
 (A) 700mA (B) 714mA (C) 1A (D) 1mA





3. The light emitted is concentrated near the junction because most of the carriers are within the diffusion length of the junction
4. Light is emitted in a LED when electrons move from the valence band to the conduction band
- Which of the following statements are correct?  
(A) 1, 2, 3 and 4      (B) 1 and 2 only      (C) 3 and 4 only      (D) 2 and 3 only
33. The collector and emitter current levels for a transistor with a common base d.c. current gain of 0.99 and base current of  $20\mu\text{A}$  are respectively:  
(A)  $2\text{mA}$ ,  $1.98\text{mA}$       (B)  $1.98\mu\text{A}$ ,  $2\text{mA}$       (C)  $1.98\text{mA}$ ,  $2\text{mA}$       (D)  $2\text{mA}$ ,  $1.98\mu\text{A}$
34. The difference between PLA and ROM is:  
(A) PLA is sequential, ROM is combinational  
(B) PLA is combinational, ROM is sequential  
(C) PLA economizes on the number of min-terms to implement Boolean functions  
(D) PLA has fixed AND array, ROM has fixed OR array
35. Consider the following statements.
1. In a silicon controlled rectifier (SCR), if the cathode gate is reverse-biased, then the SCR cannot fire at all
  2. The turn on time of an SCR increases with temperature
  3. After an SCR is turned on, it can be made to turn off again by reverse biasing the gate
  4. Gate recovery time is the minimum time that the anode voltage must be maintained below holding voltage  $V_H$  to turn off the SCR
- Which of the following statements are correct?  
(A) 1, 2, 3 and 4      (B) 1 and 2 only      (C) 2 and 4 only      (D) 3 and 4 only
36. Which one of the following statements is correct about SCR?  
(A) SCR is constructed using an npn and pnp transistor by connecting base of one transistor to collector of the other transistor  
(B) To switch off an SCR, gate current must be reduced below certain threshold value.  
(C) Higher levels of gate currents in SCR cause it to conduct at lower anode-to-cathode voltages  
(D) The higher the gate current in SCR, the higher the holding current to switch off
37. The p-type epitaxial layer grown over an n-type substrate for fabricating a bipolar transistor will function as:  
(A) The collector of a pnp transistor  
(B) The base of an npn transistor  
(C) The emitter of a pnp transistor  
(D) The collector contact for a pnp transistor

38. The biasing of an IC BJT is done by the following biasing scheme:  
 (A) Potential divider biasing scheme (B) Fixed biasing scheme  
 (C) Current mirror biasing scheme  
 (D) Collector to base feedback biasing scheme
39. Consider the following statements about CMOS.
1. CMOS logic inverter has maximum signal swing of 0V to  $V_{DD}$
  2. The output signal swing is independent of exact value of aspect ratio and other device parameters
  3. It is a fast switching device with wide noise margins
  4. It has zero input resistance and infinite output resistance
- Which of the following statements are correct?  
 (A) 1, 2, 3 and 4 (B) 1, 2 and 4 (C) 2, 3 and 4 (D) 1, 2 and 3

40. Match List I with List II

**List I**

**List II**

- |   |               |   |                                 |
|---|---------------|---|---------------------------------|
| P | LED           | 1 | Electrical isolator             |
| Q | LCD           | 2 | Forward biased                  |
| R | Opto-couplers | 3 | Light reflectors / transmitters |
| S | Photodiode    | 4 | Reverse biased                  |
- (A) P-4, Q-1, R-3, S-2 (B) P-2, Q-1, R-3, S-4  
 (C) P-4, Q-3, R-1, S-2 (D) P-2, Q-3, R-1, S-4

41. Given a unity feedback system with  $G(s) = \frac{K}{s(s+6)}$ , the value of K for damping ratio of 0.75 is:  
 (A) 1 (B) 4 (C) 16 (D) 64
42. System is said to be marginally stable, if:  
 (A) Gain crossover frequency > phase crossover frequency  
 (B) Gain crossover frequency = phase crossover frequency  
 (C) Gain crossover frequency < phase crossover frequency  
 (D) Gain crossover frequency  $\neq$  phase crossover frequency
43. System transformation function  $H(z)$  for a discrete time LTI system expressed in state variable form with zero initial condition is:  
 (A)  $c(zI - A)^{-1}b + d$  (B)  $c(zI - A)^{-1}$  (C)  $(zI - A)^{-1}z$  (D)  $(zI - A)^{-1}$



44. Unit step response of the system described by difference equation  $y(n] + y(n - 1) = x(n]$  is:

- (A)  $\frac{z^2}{(z + 1)(z - 1)}$       (B)  $\frac{z}{(z + 1)(z - 1)}$       (C)  $\frac{(z + 1)}{(z - 1)}$       (D)  $\frac{z(z - 1)}{(z + 1)}$

45. Which of the following relations is not correct?

- (A)  $f(t)\delta(t) = f(0)\delta(t)$       (B)  $\int_{-\infty}^{\infty} f(t)\delta(\tau) dt = 1$   
 (C)  $\int_{-\infty}^{\infty} \delta(\tau) d\tau = 1$       (D)  $f(t)\delta(t - \tau) = f(\tau)\delta(t - \tau)$

46. A family of constant N circles has the centre as:

- (A)  $X=1$  and  $Y=2N$       (B)  $X = -\frac{1}{4}$  and  $Y=4N$   
 (C)  $X = \frac{-1}{2}$  and  $Y = \frac{1}{4N}$       (D)  $X = \frac{-1}{2}$  and  $Y = \frac{1}{2N}$

47. Consider the circuit shown below: The portion of the circuit left to the terminals AB can be replaced by:

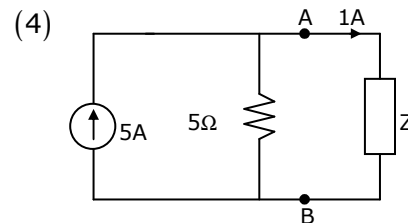
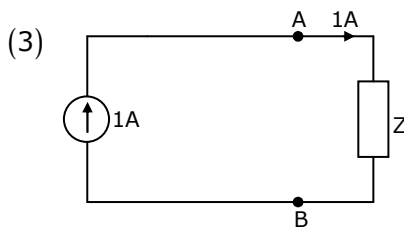
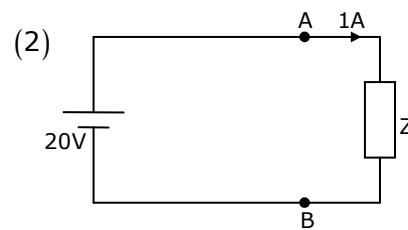
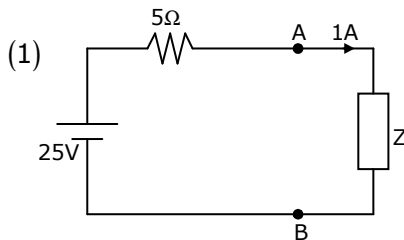
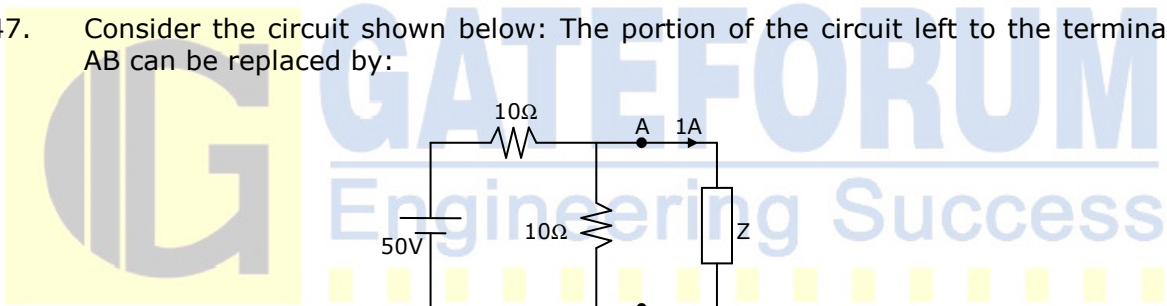

- (A) 1 and 2 only      (B) 2 and 3 only  
 (C) 1, 2 and 3 only      (D) 1, 2, 3 and 4

48. Laplace transform of the function  $f(t)$  shown in the figure is:

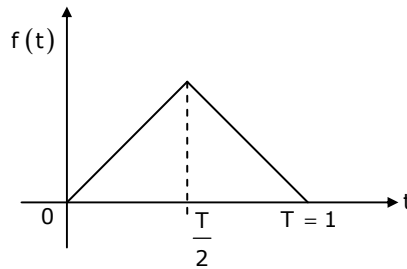

- (A)  $\frac{2}{s^2} [1 - e^{-0.5s}]^2$     (B)  $\frac{2}{s^2} [1 + e^{-0.5s}]^2$     (C)  $\frac{2}{s^2} [1 - e^{0.5s}]^2$     (D)  $\frac{2}{s^2} [1 + e^{0.5s}]^2$

49. Time constants of RL and RC circuits are respectively:

Given  $R = 1\Omega$ ;  $L=1H$  and  $C = 1F$

- (A) 1sec and 1sec    (B) 1sec and 2sec    (C) 2sec and 3sec    (D) 2sec and 4sec

50. Which one of the following gives the V-I characteristic of an ideal voltage source?

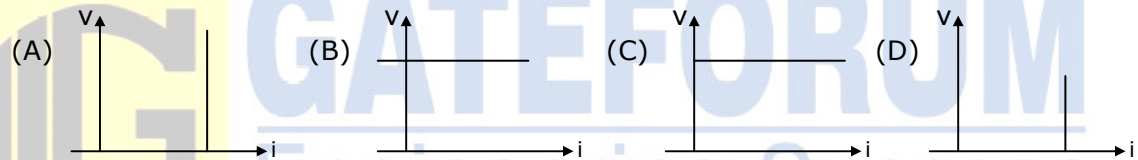

51. The circuit shown in the figure is in steady state before the switch is closed at  $t=0$ . The current  $i_s(0^+)$  through the switch is:

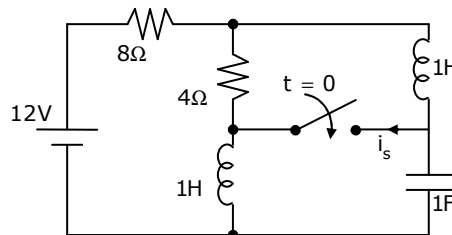

- (A) 1/3A    (B) 2/3A    (C) 1A    (D) 0A

52. Consider the following statements:

1. Voltage across a capacitor cannot change abruptly
2. Voltage across an inductor cannot change abruptly
3. Current across a capacitor cannot change abruptly
4. Current through an inductor cannot change abruptly

Which of the following statements are correct?

- (A) 1 and 2 only    (B) 2 and 3 only    (C) 3 and 4 only    (D) 1 and 4 only

53. Match List I with List II

**List I**

- P Superposition theorem
- Q Thevenin's theorem
- R Kirchoff's voltage and current laws
- S Maximum power transfer theorem

**List II**

- 1 Impedance matching in audio circuits
- 2 Linear bilateral networks
- 3 Large networks in which currents in few elements to be determined
- 4 Currents and voltages in all branches of a network

- (A) P-1, Q-4, R-3, S-2
- (C) P-1, Q-3, R-4, S-2

- (B) P-2, Q-4, R-3, S-1
- (D) P-2, Q-3, R-4, S-1

54. The current through the branch AB in the circuit shown is:

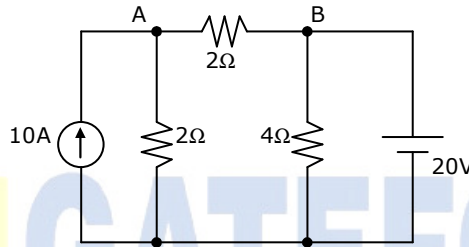

- (A) 10A from A to B
- (C) 0

- (B) 10A from B to A
- (D) 20A from B to A

55. In the circuit shown, the switch is opened at  $t=0$ . The circuit is:

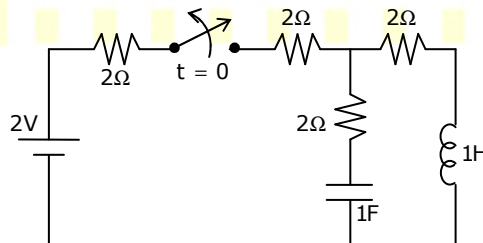

- (A) Critically damped
- (B) Under damped
- (C) Over damped
- (D) Undamped

56. In the circuit shown, the initial current  $I_0$  through the inductor is given in the figure. The initial value of the voltage across the inductor  $V_0(0^+)$  is:

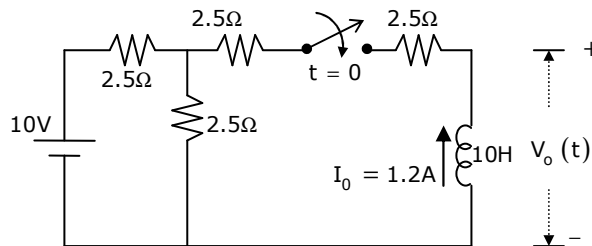

- (A) 12.5V
- (B) 5V
- (C) 10V
- (D) 0V

57. For the network shown in figure,  $Y_{11}$  and  $Y_{12}$  are respectively:

- (A)  $\frac{3}{50} \text{ } \bar{\text{O}}$  and  $-\frac{1}{30} \text{ } \bar{\text{O}}$
- (B)  $\frac{3}{50} \text{ } \bar{\text{O}}$  and  $\frac{1}{30} \text{ } \bar{\text{O}}$
- (C)  $-\frac{3}{50} \text{ } \bar{\text{O}}$  and  $-\frac{1}{30} \text{ } \bar{\text{O}}$
- (D)  $-\frac{3}{50} \text{ } \bar{\text{O}}$  and  $\frac{1}{30} \text{ } \bar{\text{O}}$

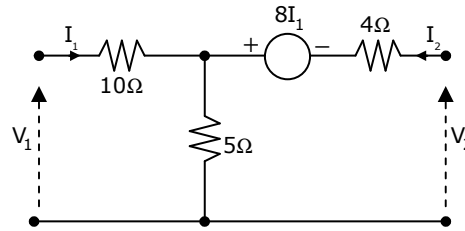

58. A two-port network satisfies the following relations:

$$4I_1 + 8I_2 = 2V_1; 8I_1 + 16I_2 = V_2$$

1. The network is reciprocal
2.  $Z_{11} = 4$  and  $Z_{12} = 8$
3.  $Z_{21} = 8$  and  $Z_{22} = 16$
4.  $Z_{11} = 2$  and  $Z_{12} = 4$

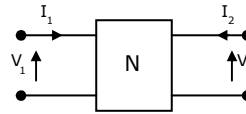

Which of these relations are correct?

- (A) 1, 2, 3 and 4      (B) 2 and 3 only      (C) 3 and 4 only      (D) 1 and 2 only

59. In the circuit shown, 2-port network N has

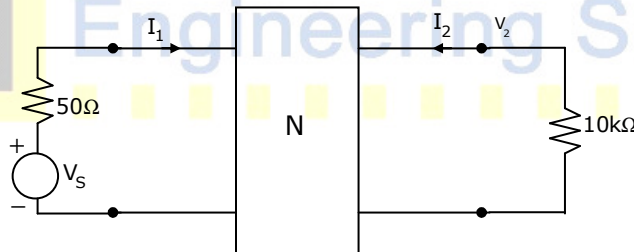

$Z_{11} = 10^3 \Omega$ ,  $Z_{12} = 10\Omega$ ,  $Z_{21} = -10^6 \Omega$  and  $Z_{22} = 10^4 \Omega$ . The current gain  $\frac{I_2}{I_1}$  is:

- (A) -50      (B) +50      (C) +20      (D) -20

60. In the 2-port network shown in the figure, the value of  $Y_{12}$  is:

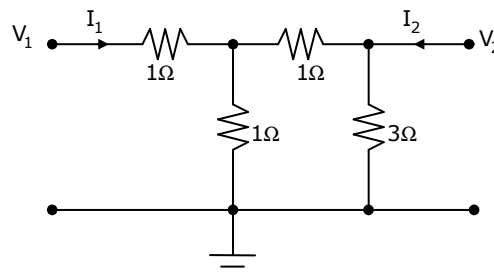

- (A) -1/3 mho      (B) +1/3 mho      (C) -3 mho      (D) +3 mho







68. If the potential  $V = 4x + 2$  volts, then the electric field is:  
 (A) 6V/m (B) 2 V/m (C) 4 V/m (D)  $4a_x$  V/m

69. If the current element represented by  $4 \times 10^3 a_y$  Amp-m is placed in a magnetic field of  $H = \frac{\rho a_x}{\mu}$  A/m, the force on the current element is:

(A)  $-2.0a_z$  mN (B)  $2.0a_z$  mN (C)  $-2.0 a_z$  N (D)  $2.0a_z$  N

70. Match List I with List II:

**List I**

**List II**

- |                 |                    |
|-----------------|--------------------|
| P MMF           | 1 Conductivity     |
| Q Magnetic flux | 2 Electric current |
| R Reluctance    | 3 Emf              |
| S Permeability  | 4 Resistance       |

(A) P-3, Q-4, R-2, S-1 (B) P-1, Q-2, R-4, S-3  
 (C) P-3, Q-2, R-4, S-1 (D) P-1, Q-4, R-2, S-3

71. Given that the electric flux density  $D = z\rho(\cos^2 \Phi)a_z$  C/m<sup>2</sup>. The charge density at point  $(1, \frac{\pi}{4}, 3)$  is

(A) 3 (B) 1 (C) 0.5 (D)  $0.5a_z$

72. Two dielectric media with permittivities 3 and  $\sqrt{3}$  are separated by a charge free boundary as shown in figure. The electric field intensity in medium 1 at point  $P_1$  has magnitude  $E_1$  and makes an angle  $\alpha_1 = 60^\circ$  with the normal. The direction of the electric field intensity at point  $(P_2, \alpha_2)$  is:

- (A)  $\sin^{-1}\left(\frac{\sqrt{3}E_1}{2}\right)$   
 (B)  $45^\circ$   
 (C)  $\cos^{-1}\left(\frac{\sqrt{3}E_1}{2}\right)$   
 (D)  $30^\circ$

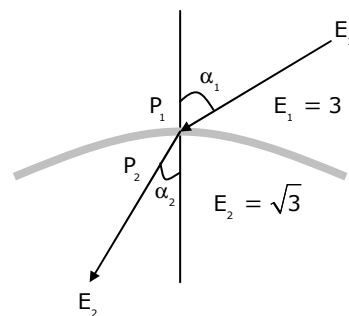

73. For no reflection condition, a vertically polarized wave should be incident at the interface between two dielectrics having  $\epsilon_1 = 4$  and  $\epsilon_2 = 9$ , with an incident angle of:

(A)  $\tan^{-1}\left(\frac{9}{4}\right)$  (B)  $\tan^{-1}\left(\frac{3}{2}\right)$  (C)  $\tan^{-1}\left(\frac{2}{3}\right)$  (D)  $\tan^{-1}\left(\frac{4}{9}\right)$

74. Assuming that each loop is stationary and time varying magnetic field  $\vec{B}$ , induces current  $I$ , which of the configurations in the figure are correct?

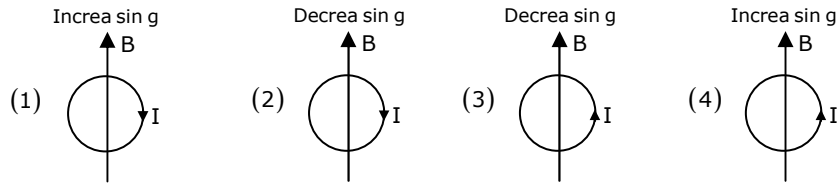

- (A) 1, 2, 3 and 4      (B) 1 and 3 only      (C) 2 and 4 only      (D) 3 and 4 only

75. The electric field component of a wave in free space is given by:

$$\vec{E} = 10 \cos(10^7 t + kZ) \vec{a}_y \text{ V/m}$$

Following is a list of possible inferences:

1. Wave propagates along  $\vec{a}_y$
2. Wavelength  $\lambda = 188.5\text{m}$
3. Wave amplitude is  $10\text{V/m}$
4. Wave number =  $0.33\text{rad/m}$
5. Wave attenuates as it travels

Which of these inferences can be drawn from  $\vec{E}$ ?

- (A) 1, 2, 3, 4 and 5      (B) 2 and 3 only      (C) 3 and 4 only      (D) 4 and 5 only

76. An electromagnetic wave of frequency  $3\text{MHz}$  passes from vacuum into a dielectric medium with permittivity  $\epsilon = 4.0$ . Then:

- (A) Wavelength is doubled and the frequency remains unchanged
- (B) Wavelength is doubled and the frequency becomes half
- (C) Wavelength is halved and the frequency remains unchanged
- (D) Both wavelength and frequency remain unchanged

77. A plane wave is generated under water ( $\epsilon = 81\epsilon_0$  and  $\mu = \mu_0$ ). The wave is parallel polarized. At the interface between water and air, the angle  $\alpha$  for which there is no reflection is:

- (A)  $83.88^\circ$
- (B)  $83.66^\circ$
- (C)  $84.86^\circ$
- (D)  $84.08^\circ$

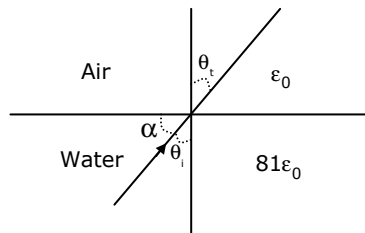

78. The characteristic impedance of TV receiving antenna cable is  $300\Omega$ . If the conductors are made of copper separated by air and are  $1\text{mm}$  thick, what is the phase velocity and phase constant when receiving VHF channel 3( $63\text{MHz}$ ) and VHF 69 ( $803\text{MHz}$ )?

- (A)  $1.32 \text{ rad/m}$  and  $17.82 \text{ rad/m}$       (B)  $1.52 \text{ rad/m}$  and  $16.82 \text{ rad/m}$

- (C) 1.52 rad/m and 17.82 rad/m                      (D) 1.32 rad/m and 16.82 rad/m
79. If maximum and minimum voltages on a transmission line are 4V and 2V respectively, then VSWR is:  
(A) 0.5                      (B) 2                      (C) 1                      (D) 8
80. An ideal lossless transmission line of  $Z_0 = 60\Omega$  is connected to unknown  $Z_L$ . If  $SWR = 4$ , then find  $Z_L$ .  
(A)  $240\Omega$                       (B)  $480\Omega$                       (C)  $120\Omega$                       (D)  $100\Omega$
81. Loading a cable is done to:  
1. Increase its inductance  
2. Increase its leakage resistance  
3. Decrease its capacitance  
4. Achieve distortion-less condition  
(A) 1, 2, 3 and 4                      (B) 1 and 2 only                      (C) 2 and 3 only                      (D) 1 and 4 only
82. Consider the following statements about the Smith chart.  
1. A complete revolution ( $360^\circ$ ) around the Smith chart represents a distance of half wavelength on the line  
2. Clockwise movement on the chart is regarded as moving toward the generator  
3. Although three scales around the periphery of Smith chart are used, only one scale can be sufficient  
4. Smith chart cannot be used as admittance chart  
Which of the above statements is correct?  
(A) 1, 2, 3 and 4                      (B) 1, 2 and 4 only  
(C) 2, 3 and 4 only                      (D) 1, 2 and 3 only
83. Consider the following statements:  
1. The antennas radiate energy  
2. An antenna is a transition device, or transducer between a guided wave and a free space wave or vice versa  
3. The resonators and transmission lines store energy  
4. An antenna converts electromagnetic signal to currents or vice versa  
Which of these statements are correct?  
(A) 1, 2 and 4 only                      (B) 1, 2 and 3 only                      (C) 2, 3 and 4 only                      (D) 1, 2, 3 and 4
84. An antenna can be modelled as an electric dipole of length 5m at 3MHz. Find the reduction resistance of the antenna assuming uniform current over the length.  
(A)  $2\Omega$                       (B)  $1\Omega$                       (C)  $4\Omega$                       (D)  $0.5\Omega$

85. Match List I with List II and select the correct answer using the codes given below the list:

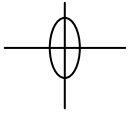
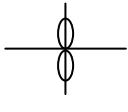
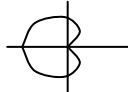
<b>List I</b>		<b>List II</b>
P	Two isotropes half wavelength apart fed in phase	1 
Q	Two isotropes quarter wavelength apart 90° phase shift	2 
R	Two isotropes quarter wavelength apart fed in phase	3 

- (A) P-1, Q-3, R-2      (B) P-2, Q-3, R-1      (C) P-1, Q-2, R-3      (D) P-2, Q-1, R-3

86. An antenna located on the surface of a flat earth transmits an average power of 200kW. Assuming that all the power is radiated uniformly over the surface of a hemisphere with the antenna at the center, the time average Poynting vector at 50km is:

- (A) Zero      (B)  $\frac{2}{\pi} \text{ a}_1 \text{ W/m}^2$       (C)  $\frac{40}{\pi} \mu\text{W/m}^2$       (D)  $\frac{40}{\pi} \text{ a}_1 \mu\text{W/m}^2$

87. Which one of the following meters has maximum loading effect on the circuit under measurement?

- (A)  $1000\Omega/V$       (B)  $100\Omega/V$       (C)  $1M\Omega/V$       (D)  $10M\Omega/V$

88. A second order pressure transducer has a natural frequency of 30rad/s, static sensitivity  $K = 1.0\mu\text{V/Pa}$ . When a step pressure input of  $8 \times 10^5 \frac{\text{N}}{\text{m}^2}$  is applied, damped frequency of 29.85rad/s is observed. The damping ratio of the transducer is:

- (A) 0      (B) 0.707      (C) 1.0      (D) 0.1

89. A voltmeter with an internal resistance of 200k $\Omega$  when connected across an unknown resistance reads 250V. The milli ammeter with internal resistance =0 connected in series with the above combination reads 10mA. The actual value of the unknown resistance is:

- (A) 25k $\Omega$       (B) 200k $\Omega$       (C) 25.56k $\Omega$       (D) 20k $\Omega$

90. The figure below shows the circuit of a rectifier type voltmeter.

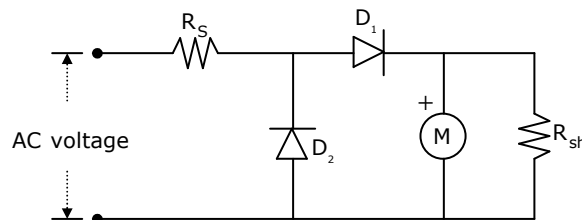

The diode  $D_2$

1. Does not allow any current to flow through the meter during negative half cycle
  2. Does not allow reverse leakage current to flow through the meter during negative half cycle
  3. Short circuits the meter during negative half cycle
- Which of these statements are correct?  
(A) 1 and 2 only      (B) 2 and 3 only      (C) 1 and 3 only      (D) 1, 2 and 3
91. A good S/H circuit should have:
1. High input impedance
  2. High output impedance
  3. Low input impedance
  4. Low output impedance
- (A) 1 and 2 only      (B) 2 and 3 only      (C) 3 and 4 only      (D) 1 and 4 only
92. When a sinusoidal signal of 220V, 50Hz produces on CRO a vertical deflection of 2cm at a particular setting of the vertical gain control, what would be the value of the voltage to be applied to produce a deflection of 3cm for the same vertical gain?  
(A) 330V      (B) 110V      (C) 220V      (D) 55V
93. A 1000Hz sinusoidal voltage is connected to both X and Y inputs of a CRO. Which of the following waveforms is seen on CRO?  
(A) Sine wave      (B) Circle      (C) Ellipse      (D) Straight line
94. A dual slope A/D converter:
1. Responds very fast
  2. Has better accuracy
  3. Requires an accurate and stable d.c. source
  4. Requires a buffer at the input side
- (A) 1 is not correct      (B) 2 and 3 are correct  
(C) 3 and 4 are correct      (D) 1, 2, 3 and 4 are correct
95. A digital voltmeter has  $4\frac{1}{2}$  digit display. The 1V range can read up to:  
(A) 1.0000V      (B) 1.1111V      (C) 0.9999V      (D) 1.9999V
96. Consider the following statements for an N-bit DACs:
1. R-2R ladder type is based on dual slope integration
  2. R-2R requires resistors of large spread in values
  3. R-2R requires roughly 2N resistors
  4. R-2R requires roughly N number of resistors
- Which of the following statements are correct?  
(A) 3 only      (B) 1 only      (C) 1 and 3      (D) 2 and 4

97. A 10 bit A/D converter is used in a DMM. The maximum peak to ripple voltage allowed in the d.c. supply voltage for a measurement range of 0 to 5V is:  
 (A) 100 mV (B) 25 mV (C) 5 mV (D) 50 mV

98. Match List I with List II

<b>List I</b>		<b>List II</b>	
P	Hot wire	1	Gas flow
Q	LVDT	2	Displacement
R	Piezoelectric	3	Current
S	Hall effect	4	Acceleration
(A) P-1, Q-4, R-2, S-3		(B) P-3, Q-4, R-2, S-1	
(C) P-1, Q-2, R-4, S-3		(D) P-3, Q-2, R-4, S-1	

99. Match List I with List II

<b>List I</b>		<b>List II</b>	
P	Chromel-Alumel	1	Long life and low thermal conductivity
Q	Iron Constantan	2	Inexpensive and mechanically strong
R	Platinum Rhodium	3	Low sensitivity and high stability
S	Copper Constantan	4	Suitable for measurement below 0°C and high reliability
(A) P-1, Q-2, R-3, S-4		(B) P-4, Q-2, R-3, S-1	
(C) P-1, Q-3, R-2, S-4		(D) P-4, Q-3, R-2, S-1	

100. A platinum resistance thermometer has a resistance of 140.5  $\Omega$  at 100°C and 100  $\Omega$  at 0°C. When it is in contact with a hot gas, its resistance becomes 305.3  $\Omega$ . The temperature of the gas (Assuming temperature coefficient of platinum is 0.004/°C) is close to:  
 (A) 300°C (B) 400 °C (C) 500 °C (D) 600 °C

101. Optical pyrometer is generally used to measure:  
 (A) Low pressure (B) Low temperature  
 (C) High temperature (D) High pressure

102. Match List I with List II

<b>List I</b>		<b>List II</b>	
P	Ferrite	1	Miessner effect
Q	Superconductor	2	Faraday effect
R	Quartz	3	Hysteresis
S	Iron	4	Piezoelectricity
(A) P-3, Q-1, R-4, S-2		(B) P-2, Q-1, R-4, S-3	
(C) P-3, Q-4, R-1, S-2		(D) P-2, Q-4, R-1, S-3	



103. What is the output voltage for the circuit shown below?

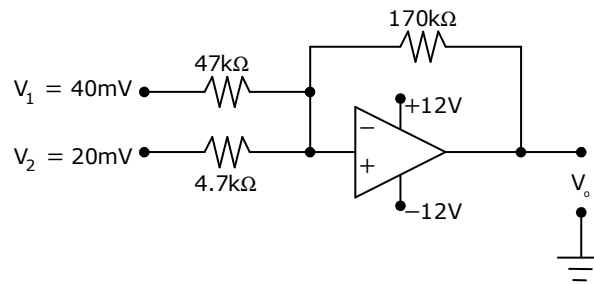

- (A) -4.8V                      (B) +1.2V                      (C) -2.4V                      (D) +2.4V

104. Doping intrinsic Silicon with Arsenic as an impurity:

- (A) Only increases the conductivity of Silicon by increasing the number of free electrons available
- (B) Produces a semiconductor in which the charge carriers are predominantly electrons but holes are also present
- (C) Produces a semiconductor in which the charge carriers are predominantly holes but free electrons are also present
- (D) Produces a semiconductor in which the charge carriers contain nearly equal number of electrons and holes

105. A dipole with a length of 1.5m operates at 100MHz while the other has a length of 15m and operates at 10MHz. The dipoles are fed with same current. The power radiated by the two antennas will be:

- (A) The longer antenna will radiate 10 times more power than the shorter one
- (B) Both antennas radiate same power
- (C) Shorter antenna will radiate 10 times more power than the longer antenna
- (D) The longer antenna will radiate  $\sqrt{10}$  times more power than the shorter one

**Following 15 (fifteen) items consist of two statements, one labelled as the Assertion (A) and the other as Reason (R). You are to examine these two statements carefully and select the answers to these items using the codes given below:**

- (A) Both A and R are individually true and R is the correct explanation of A
- (B) Both A and R are individually true but R is not the correct explanation of A
- (C) A is true but R is false
- (D) A is false but R is true

106. **Assertion** : The bias stability of a self bias amplifier circuit can be improved by increasing values of both the base resistor  $R_b$  and the emitter resistor  $R_E$ .

- Reason** : The base resistor  $R_B$  provides the required voltage to the base terminal and the emitter resistor  $R_E$  provides negative feedback to the amplifier
107. **Assertion** : Thermal runaway occurs in FET circuits but it does not occur in BJT circuit
- Reason** : FET is a majority carrier device whereas BJT works based on the movement of both the majority and the minority carriers.
108. **Assertion** : Good conductors do not show superconductivity
- Reason** : Electron-phonon interaction that leads to formation of Cooper pairs is weak in good conductors
109. **Assertion** : The typical common base output characteristics of a bipolar junction transistor remains almost parallel to the voltage axis, but shows very little increase in current with increase in the output voltage
- Reason** : The short circuit common base current gain  $\alpha$  of a bipolar transistor increases with increase in the temperature
110. **Assertion** : The reverse saturation current approximately doubles for every  $10^\circ\text{C}$  temperature rise for both Si and Ge materials
- Reason** : At room temperature, the p-n junction voltage decreases by about  $2.5\text{mV}$  per  $^\circ\text{C}$  with rise in temperature
111. **Assertion** : The resistance of a FET in non conducting region is very high.
- Reason** : The FET is a semiconductor device
112. **Assertion** : It is desired that the high frequency transistors should work at low collector currents for better high frequency performance
- Reason** : The diffusion capacitance is directly proportional to the emitter current
113. **Assertion** : In a transistor, it is desirable that the carriers contributing to emitter current in the active mode reach the collector terminal
- Reason** : The conductivity of the base in a transistor is made much smaller than the conductivity of the emitter
114. **Assertion** : Concentration of acceptor atoms in the region between isolation islands will be much higher p+ than in the p-type substrate in an integrated circuit

- Reason** : This is to prevent the depletion region of the reverse-biased isolation to substrate junction from extending into p+ type material
115. **Assertion** : The power factor of an inductor is zero  
**Reason** : The voltage across and current through the inductor are in quadrature
116. **Assertion** : When a series RLC circuit is in resonance, the current flowing in the circuit is maximum  
**Reason** : The inductive reactance and the capacitive reactance are equal in magnitude at resonance
117. **Assertion** : Under static conditions, the surface of conductor is an equi-potential surface  
**Reason** : The tangential component of electric field on conductor surface is zero
118. **Assertion** : For time varying field the relation  $\vec{E} = -\nabla V$  is inadequate  
**Reason** : Faraday's law states that for time varying field,  $\nabla \times \vec{E} = 0$
119. **Assertion** : The ratio of the tangential components of current density at two sides of an interface are equal to the conductivities  
**Reason** : The normal component of current density is continuous
120. **Assertion** : Effect of frequency on calibration is also due to spurious capacitive currents  
**Reason** : Spurious capacitive current does not occur in thermocouple instruments