

Test Booklet Code

A

PCE-2008

Test Booklet No.

895517

This booklet contains 24 pages.

DO NOT open this Test Booklet until you are asked to do so.

Important Instructions :-

1. The PHYSICS & CHEMISTRY test is consist of **80** questions. Each question carries **1** mark. For each correct response the candidate will get **1** mark. For each incorrect response, $\frac{1}{4}$ mark will be deducted. The maximum marks are **80**.
2. The Test is of **2 hours** duration.
3. Use **Black Ball Point Pen only** for writing particulars on OMR Answer Sheet marking
• responses.
4. Rough work is to be done on the space provided for this purpose in the Test Booklet only.
5. **On completion of the test, the candidate must handover the Answer Sheet to the Invigilator in the Room / Hall. The candidates are allowed to take away this Test Booklet with them.**
6. The CODE for this Booklet is **A**. Make sure that the CODE printed on the Answer Sheet is the same as that on this booklet. In case of discrepancy, the candidate should immediately report the matter to the Invigilator for replacement of both the Test Booklet and the Answer Sheet.
7. The candidate should ensure that the Answer Sheet is not folded. Do not make any stray marks on the Answer Sheet.
8. Do not write your Seat No. anywhere else, except in the specified space in the Test Booklet / Answer Sheet.
9. Use of White fluid for correction is not permissible on the Answer Sheet.
10. Each candidate must show, on demand his / her Admission Card to the Invigilator.
11. No candidate, without special permission of the Superintendent or Invigilator, should leave his / her seat.
12. Use of Manual Calculator is permissible.
13. The candidate should not leave the Examination Hall without handing over their Answer Sheet to the Invigilator on duty and must sign the Attendance Sheet (Patrak - 01). Cases where a candidate has **not** signed the Attendance Sheet (Patrak-01) be deemed not to have handed over the Answer Sheet and dealt with as a unfair means case.
14. The candidates are governed by all Rules and Regulations of the Board with regard to their conduct in the Examination Hall. All cases of unfair means will be dealt with as per Rules and Regulations of the Board.
15. No part of the Test Booklet and Answer Sheet shall be detached under any circumstances.
16. The candidates will write the Correct Test Booklet Code as given in the Test Booklet / Answer Sheet in the Attendance Sheet. (Patrak-01)

Candidate's Name

Exam. Seat No. (in figures) (in words)

Name of Exam. Centre Exam. Centre No. :

Test Booklet Code : Test Booklet No. :

Candidate's Sign Block Supt. Sign

PHYSICS

1. A circle of radius ' a ' has charge density given by $\lambda = \lambda_0 \cos^2 \theta$ on its circumference. What will be the total charge on the circle ?
- (A) $\pi a \lambda_0$ (B) Zero
(C) $2 \pi a$ (D) None of these
2. Electrical force between two point charges is 200 N. If we increase 10% charge on one of the charges and decrease 10% charge on the other, then electrical force between them for the same distance becomes
- (A) 200 N (B) 99 N
(C) 198 N (D) 100 N
3. If 20 J of work has to be done to move an electric charge of 4 C from a point, where potential is 10 volt to another point, where potential is V volt, find the value of V.
- (A) 5 volt (B) 15 volt
(C) 2 volt (D) 70 volt
4. Eight charges, each of magnitude q are placed at the vertices of a cube placed in vacuum. Electric potential at the centre of the cube due to this system of charges is
- (ϵ_0 is permittivity of vacuum and a is length of each side of the cube)
- (A) Zero (B) $\frac{\sqrt{3} q}{\pi \epsilon_0 a}$
(C) $\frac{2q}{\pi \epsilon_0 a}$ (D) $\frac{4q}{\sqrt{3} \pi \epsilon_0 a}$

(Space for Rough Work)

5. 64 small drops of water having same charge and same radius are combined to form one big drop. The ratio of capacitance of big drop to small drop is
 (A) 4 : 1 (B) 1 : 4
 (C) 2 : 1 (D) 1 : 2
6. Equivalent capacitance between X and Y point in the given figure is

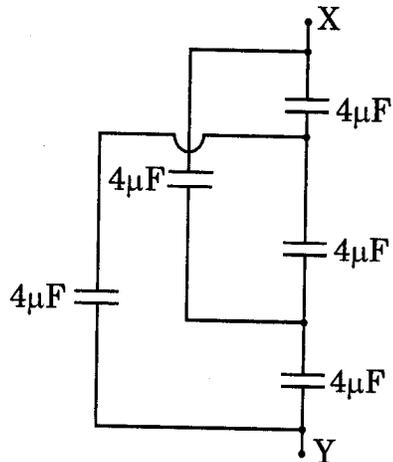

- (A) $3\ \mu\text{F}$
 (B) $1\ \mu\text{F}$
 (C) $2\ \mu\text{F}$
 (D) $4\ \mu\text{F}$
7. Cross-sectional area of a Copper wire is equal to area of a square of length 2 mm. If this copper wire draws 8 A electric current, then find the drift velocity of free electron. Number density of electron in Copper wire is $8 \times 10^{28}\ \text{m}^{-3}$.
 (A) $1.56 \times 10^{-4}\ \text{ms}^{-1}$ (B) $1.56 \times 10^{-2}\ \text{ms}^{-1}$
 (C) $3.12 \times 10^{-3}\ \text{ms}^{-1}$ (D) $3.12 \times 10^{-2}\ \text{ms}^{-1}$

(Space for Rough Work)

8. The internal resistance of a cell of *emf* 4 V is 0.1Ω . It is connected to a resistance of 3.9Ω . The voltage across the cell will be
- (A) 0.1 V (B) 3.8 V
(C) 3.9 V (D) 2 V
9. The ratio of cross-sectional areas of two conducting wires made up of same material and having same length is 1 : 2. What will be the ratio of heat produced per second in the wires, when same current is flowing in them ?
- (A) $1 : \sqrt{2}$ (B) 1 : 1
(C) 1 : 4 (D) 2 : 1
10. Two electric bulbs are connected one by one across potential difference V. At that time power consumed in them are P_1 and P_2 respectively. Now, if potential difference V is applied across series combination of these bulbs, what will be total power consumed ?
- (A) $P_1 + P_2$ (B) $\sqrt{P_1 P_2}$
(C) $\frac{P_1 P_2}{P_1 + P_2}$ (D) $P_1 P_2$
11. First order derivation of thermo *emf* produced in thermo-couple with respect to temperature gives
- (A) Neutral temperature (B) Thermo electric power
(C) Inversion temperature (D) Thomson coefficient

(Space for Rough Work)

12. The deflection in Moving-coil Galvanometer falls from 50 divisions to 10 divisions, when a shunt of 12Ω is connected with it. The resistance of Galvanometer coil is
- (A) 6Ω (B) 48Ω
(C) 24Ω (D) 12Ω
13. A current flows in a conducting wire of length L . If we bend it in a circular form, its magnetic dipole moment would be
- (A) $\frac{I^2 L}{4\pi}$ (B) $\frac{I^2 L^2}{4\pi}$
(C) $\frac{IL^2}{4\pi}$ (D) $\frac{IL}{4\pi}$
14. At a given place on the Earth, the angle between the Magnetic meridian and the Geographic meridian is called
- (A) Magnetic latitude (B) Magnetic dip
(C) Magnetic longitude (D) Magnetic declination
15. In an A.C. circuit, a resistance of R ohm is connected in series with an inductor of self inductance L . If phase angle between voltage and current be 45° , the value of inductive reactance (X_L) will be equal to
- (A) $\frac{R}{4}$ (B) $\frac{R}{2}$
(C) R (D) $\frac{R}{8}$

(Space for Rough Work)

16. The north pole of a magnet is falling on a metallic ring as shown in the figure. The direction of induced current, if looked from upside in the ring will be

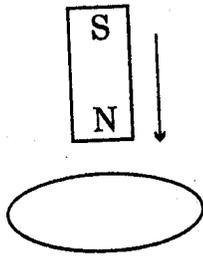

- (A) Anticlock-wise.
(B) Clock-wise.
(C) Clock-wise or anticlock-wise depending on metal of the ring.
(D) No induced current.
17. At time $t = 0$ second, voltage of an A.C. Generator starts from 0V and becomes 2V at time $t = \frac{1}{100\pi}$ second. The voltage keeps on increasing up to 100 V, after which it starts to decrease. Find the frequency of the Generator.
- (A) 100 Hz
(B) 1 Hz
(C) 2 Hz
(D) 5 Hz
18. X and Y, two metallic coils are arranged in such a way that, when steady change in current flowing in X coil is 4 A, change in magnetic flux associated with coil Y is 0.4 Wb. Mutual inductance of the system of these coils is H.
- (A) 0.8
(B) 0.1
(C) 0.2
(D) 5

(Space for Rough Work)

22. A ray of light travelling in water is incident on a glass plate immersed in it. When the angle of incidence is 51° , the reflected ray is totally plane polarized, then find out the refractive index of Glass.
[The refractive index of Water is 1.3 and $\tan 51^\circ = 1.235$]
(A) 1.605 (B) 1.305
(C) 1.33 (D) 1.805
23. In Fraunhofer diffraction by a single slit, a position where first order minimum is formed by the wavelength of 9000 \AA , first order maximum is formed due to an unknown wavelength λ' is
(A) 6000 \AA (B) 4000 \AA
(C) 8000 \AA (D) 2000 \AA
24. In Young's experiment, the distance between two slits is halved and the distance between the screen and slit is made three times. Then width of the fringe
(A) becomes 6 times. (B) becomes 4 times.
(C) becomes half. (D) remains the same.
25. Ratio of intensities of two waves is given by 9:1. Then ratio of their amplitudes is
- (A) 3:1 (B) 2:1
(C) 9:1 (D) 1:9
26. Which of the following undergoes largest diffraction ?
(A) γ -rays (B) Ultra-violet light
(C) Infra-red light (D) Radio waves

(Space for Rough Work)

27. The diameter of the lens of a telescope is 0.61 m. Wave-length of light is 5000 \AA . The resolution power of the telescope is -
- (A) 2×10^6 (B) 10^6
(C) 2×10^4 (D) 2×10^2
28. The photoelectric threshold wavelength for Potassium having work function of 2 eV, is
- (Take $h = 6.6 \times 10^{-34} \text{ J s}$; $1 \text{ eV} = 1.6 \times 10^{-19} \text{ J}$; $C = 3 \times 10^8 \text{ ms}^{-1}$)
- (A) 1240 nm (B) 310.7 nm
(C) 1860 nm (D) 618.7 nm
29. A Photon of energy 8 eV is incident on a metal surface of threshold frequency $1.6 \times 10^{15} \text{ Hz}$. The maximum Kinetic energy of photo electrons emitted is
- (Take $h = 6.6 \times 10^{-34} \text{ J s}$; $1 \text{ eV} = 1.6 \times 10^{-19} \text{ J}$)
- (A) 4.2 eV (B) 2.8 eV
(C) 1.4 eV (D) 0.8 eV
30. What will be the angular momentum in fourth orbit, if L is the angular momentum of the electron in the second orbit of Hydrogen atom ?
- (A) $\frac{2}{3}L$ (B) $\frac{L}{2}$
(C) $2L$ (D) $\frac{3}{2}L$

(Space for Rough Work)

31. An α particle and a deuteron are moving with velocities v and $2v$ respectively. What will be the ratio of their de-Broglie wavelengths ?

(A) $1:\sqrt{2}$

(B) $2:1$

(C) $1:1$

(D) $\sqrt{2}:1$

32. Ultraviolet light by wavelength 200 nm is incident on polished surface of Fe (Iron). Work function of the surface is 4.71 eV. What will be its stopping potential ?

($h = 6.626 \times 10^{-34}$ J s ; $1 \text{ eV} = 1.6 \times 10^{-19}$ J ; $c = 3 \times 10^8 \text{ ms}^{-1}$)

(A) 1.5 V

(B) 2.5 V

(C) 0.5 V

(D) None of these

33. The number of Photons of wavelength 660 nm emitted per second by an electric bulb of 60 W is

(Take $h = 6.6 \times 10^{-34}$ J s)

(A) 2×10^{-20}

(B) 2×10^{20}

(C) 3×10^{20}

(D) 1.5×10^{20}

34. Complete the following nuclear reaction :

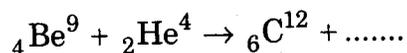

(A) p (Proton)

(B) e (Electron)

(C) n (Neutron)

(D) ν (Neutrino)

(Space for Rough Work)

35. A T.V. tower has a height of 75 m. What is the maximum distance up to which this T.V. transmission can be received ?

(Radius of the Earth = 6.4×10^6 m)

- (A) 40.98 km (B) 50.98 km
(C) 30.98 km (D) 38.98 km

36. Which one of the entries given in the truth table is true for the following logic circuit ?

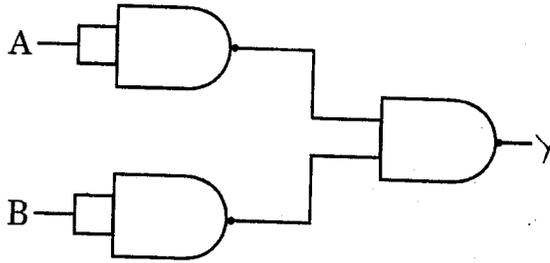

Entry No.	Input A	Input B	Output Y
1.	0	0	1
2.	0	1	0
3.	1	0	1
4.	1	1	0

- (A) 1 (B) 2
(C) 3 (D) 4

37. The frequency of audio analog signals lies in the range

- (A) 20 Hz to 20 MHz (B) 20 Hz to 20 kHz
(C) 20 kHz to 20 MHz (D) 12 Hz to 20 MHz

38. Advantages of optical fibre communications over two wire transmission line or co-axial cable transmission are

- (A) high band width, low transmission loss.
(B) low band width, high transmission loss.
(C) low band width, low transmission loss.
(D) high band width, high transmission loss.

(Space for Rough Work)

39. A pure Ge specimen is doped with Al. The number density of acceptor atoms is approximately 10^{21} m^{-3} . If density of electron hole pair in an intrinsic semi-conductor is approximately 10^{19} m^{-3} , the number density of electrons in the specimen is

(A) 10^{17} m^{-3}

(B) 10^{15} m^{-3}

(C) 10^4 m^{-3}

(D) 10^2 m^{-3}

40. An AND gate is followed by a NOT gate in series. With two inputs A & B, the Boolean expression for the output Y will be

(A) $A \cdot B$

(B) $A + B$

(C) $\overline{A + B}$

(D) $\overline{A \cdot B}$

(Space for Rough Work)

CHEMISTRY

41. The presence of unpaired electron in Phosphorus atom is explained by which principle ?
- (A) Pauli exclusion principle (B) Auf-bau principle
(C) Heisenberg's principle (D) Hund's rule
42. If a cricket ball having mass of 200 gms is thrown with a speed of 3×10^3 cm/sec., then calculate the wavelength related to it.
- (A) 1.104×10^{-32} cm. (B) 2.2×10^{-27} cm.
(C) 1.104×10^{-33} cm. (D) 1.104×10^{-27} cm.
43. Which type of stacking pattern is found in Sodium chloride's crystal lattice ?
- (A) a - a - a (B) a - b - a - b
(C) a - b - c - a - b - c (D) None of these
44. Which type of silicate compound, the Beryl is ?
- (A) Chain silicate (B) Cyclic silicate
(C) Planar silicate (D) Di-silicate
45. Find out the osmotic pressure of 0.25 M aqueous solution of Urea at 27°C.
(R = 0.082 Lit. atm./mol. K., R = 1.987 Cal.)
- (A) 0.615 atm (B) 6.15 atm
(C) 61.5 atm (D) 0.0615 atm

(Space for Rough Work)

46. Which one is true from the following for Isobaric process ?
- (A) $\Delta q = 0$ (B) $\Delta P = 0$
 (C) $\Delta E = 0$ (D) $\Delta H = 0$
47. Which is included in thermodynamic equilibrium from the following ?
- (A) Chemical equilibrium. (B) Pressure equilibrium.
 (C) Thermo equilibrium. (D) All of these.
48. What will be the proportion of moles of metal (Cu : Ni : Ag) at Cathode according to the Second law of Faraday ?
- (A) 2 : 2 : 1 (B) 1 : 2 : 1
 (C) 1 : 1 : 2 (D) 1 : 2 : 2
49. Which Nernst equation is true to find out the potential of non-standard electrochemical cell from the following ?

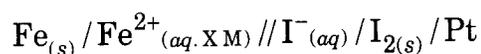

(A) $E_{\text{cell}} = E_{\text{cell}}^{\circ} - \frac{0.0592}{n} \log_{10} [\text{Fe}^{2+}] [\text{I}^{-}]^2$

(B) $E_{\text{cell}} = E_{\text{cell}}^{\circ} - \frac{0.592}{n} \log_{10} [\text{Fe}^{2+}] [\text{I}^{-}]^2$

(C) $E_{\text{cell}} = E_{\text{cell}}^{\circ} - \frac{0.0592}{nF} \log_{10} \frac{[\text{Fe}^{2+}] [\text{I}^{-}]^2}{[\text{Fe}] [\text{I}_2]}$

(D) $E_{\text{cell}} = E_{\text{cell}}^{\circ} - \frac{0.0592}{n} \log_{10} [\text{Fe}^{2+}] [\text{I}^{-}]$

(Space for Rough Work)

50. The order of a reaction for an esterification process is

- (A) First (B) Zero
(C) Pseudo First order (D) Second order

51. Which equation is true to calculate the energy of activation, if the rate of reaction is doubled by increasing temperature from T_1 K to T_2 K.

(A) $\log_{10} \frac{K_2}{K_1} = \frac{E_a}{2.303 R} \left[\frac{1}{T_2} - \frac{1}{T_1} \right]$

(B) $\log_{10} \frac{K_1}{K_2} = \frac{E_a}{2.303 R} \left[\frac{1}{T_1} - \frac{1}{T_2} \right]$

(C) $\log_{10} 2 = \frac{E_a}{2.303 R} \left[\frac{1}{T_1} - \frac{1}{T_2} \right]$

(D) $\log_{10} \frac{1}{2} = \frac{E_a}{2.303} \left[\frac{1}{T_2} - \frac{1}{T_1} \right]$

52. When plotted a graph of concentration \rightarrow Time for zero order reaction, then the value of Slope is -

- (A) $-2.303 \times K$ (B) $-\frac{K}{2.303}$
(C) $-\frac{E_a}{2.303 R}$ (D) $-K$

(Space for Rough Work)

58. Find out the Normality of a solution, when 9.8 gms. of H_2SO_4 is dissolved in 500 ml solution.
- (A) 0.4 (B) 0.2
(C) 0.8 (D) 4.0
59. On which factors, the stability of an oxidation state in Lanthenide elements depends ?
- (A) Internal energy.
(B) Enthalpy.
(C) Electronic configuration.
(D) Combined effect of hydration energy and ionization energy.
60. Potassium dichromate is used -
- (A) as a reducing agent.
(B) in electroplating.
(C) as an insecticide.
(D) It oxidises ferrous ions into ferric ions in acidic media as an oxidizing agent.
61. How many electrons are present in $3d$ orbital of tetrahedral $\text{K}_2[\text{NiCl}_4]$ complex.
- (A) 10 electrons (B) 8 electrons
(C) 6 electrons (D) 7 electrons

(Space for Rough Work)

62. Which ligand is useful for removal of the toxic effect of lead metal in body in chelate therapy treatment.

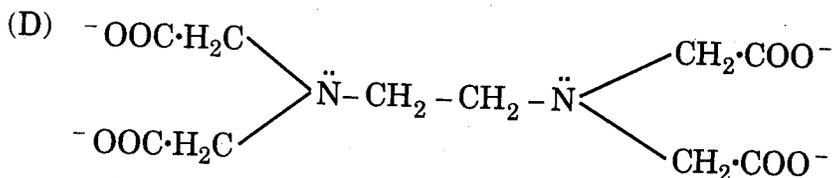
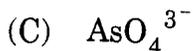
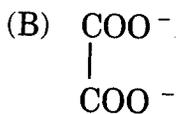

63. How many numbers of neutrons will be present in newly formed compound

when two α particles and one β particle are emitted from ${}_{94}^{244}\text{M}$?

(A) 145

(B) 146

(C) 148

(D) 150

64. Find out the half life period of ${}_{6}^{14}\text{C}$ whose decay constant is

$$2.25 \times 10^{-4} \text{ year}^{-1}.$$

(A) 3000 years

(B) 3080 years

(C) 5730 years

(D) 5780 years

65. How many numbers of possible stereo-isomers are there of 2, 3, 4 tri chloro pentanoic acid ?

(A) 12

(B) 8

(C) 4

(D) 16

(Space for Rough Work)

66. Which of the following stereo-isomer is very active in construction of blood vessels ?
- (A) (-) Nicotine (B) (+) Adrenaline
(C) S - Ibuprofen (D) (-) Thyroxine
67. Which two of the following statements are correct for Phenol ?
- (1) Phenol is more acidic than alcohol.
(2) Phenol is used in production of melamine plastic.
(3) Phenol gives violet colour with neutral Ferric chloride solution.
(4) Phenol when heated with acetyl chloride gives Phenetole.
- (A) Statements (1) and (3).
(B) Statements (2) and (3).
(C) Statements (1) and (4).
(D) Statements (3) and (4).
68. On oxidation of organic compound A with $\text{Na}_2\text{Cr}_2\text{O}_7$ and H_2SO_4 gives compound B, which on reduction with H_2 in presence of Ni catalyst gives Ethyl alcohol. Give the name of compound A.
- (A) Ethanol (B) Ethanal
(C) Ethene (D) Ethanoic acid
69. Which product will be obtained by Grignard reaction, when Formaldehyde reacts with Ethyl magnesium iodide ?
- (A) 2 - Propanol (B) 1 - Propanol
(C) Ethanol (D) 2 - Methyl, 2 - Propanol

(Space for Rough Work)

70. The formation of Cyanohydrin from Acetone is which type of reaction ?
- (A) Electrophilic addition reaction.
(B) Electrophilic substitution reaction.
(C) Nucleophilic substitution reaction.
(D) Nucleophilic addition reaction.
71. Which one is not a Sandmeyer reagent ?
- (A) $\text{Cu}_2\text{Cl}_2 + \text{HCl}$ (B) $\text{Cu}_2\text{Br}_2 + \text{HBr}$
(C) $\text{Cu}_2(\text{CN})_2 + \text{KCN}$ (D) $\text{Cu}_2\text{I}_2 + \text{KI}$
72. Which is the incorrect name of CH_3NC ?
- (A) Methyl isocyanide (B) Aceto isonitrile
(C) Methyl isonitrile (D) Methyl carbylamine
73. State the monomer of Teflon.
- (A) $\text{CH}_2=\text{CH}\cdot\text{Cl}$ (B) $\text{CF}_2 = \text{CF}_2$
(C) $\text{CH}_2=\text{CH}\cdot\text{CN}$ (D) $\text{CH}_2 = \underset{\text{Cl}}{\text{C}} - \text{CH} = \text{CH}_2$
74. Which one of the following is not a homo-polymer ?
- (A) Dacron (B) Butyl rubber
(C) Bakelite (D) Buna-S

(Space for Rough Work)

75. Which one of the following statements is incorrect for the Sucrose ?
- (A) It is not reducing sugar.
 - (B) It is obtained from cane sugar.
 - (C) It gives aspartame when it is heated at 210°C.
 - (D) On hydrolysis, it gives equal quantities of D-glucose and D-fructose.
76. What is the chemical name of the vitamin B₁₂ ?
- (A) Thiamin
 - (B) Riboflavin
 - (C) Pyridoxin
 - (D) Cyanocobalamine
77. A base-sugar phosphate unit in Nucleic acid is called
- (A) Phosphotide
 - (B) Neucleoside
 - (C) Neucleotide
 - (D) None of these
78. Which substance is obtained when Kaolin is heated at high temperature ?
- (A) Alitame
 - (B) Ceramics
 - (C) Sodium metabisulphite
 - (D) Sodium hydrosulphite

(Space for Rough Work)

79. Cetyl tri methyl ammonium chloride is which type of detergent ?

(A) Anionic

(B) Cationic

(C) Non-ionic

(D) Biosoft

80. Name the end product in the following series of reaction.

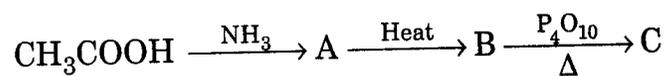

(A) CH_4

(B) CH_3OH

(C) CH_3CN

(D) $\text{CH}_3\text{COONH}_4$

(Space for Rough Work)

(Space for Rough Work)



EAL