

2007

IN: Instrumentation Engineering

Duration : Three Hours

Maximum Marks :150

Read the following instructions carefully.

1. This question paper contains 85 objective type questions. Q.1 to Q.20 carry **one** mark each and Q.21 to Q.85 carry **two** marks each.
2. Attempt all the questions.
3. Questions must be answered on **Objective Response Sheet (ORS)** by darkening the appropriate bubble (marked A, B, C, D) using HB pencil against the question number on the left hand side of the **ORS**. **Each question has only one correct answer**. In case you wish to change an answer, erase the old answer completely.
4. Wrong answers will carry **NEGATIVE** marks. In Q.1 to Q.20, **0.25** mark will be deducted for each wrong answer. In Q.21 to Q.76, Q.78, Q.80, Q.82 and in Q.84, **0.5** mark will be deducted for each wrong answer. However, there is no negative marking in Q.77, Q.79, Q.81, Q.83 and in Q.85. More than one answer bubbled against a question will be taken as an incorrect response. Unattempted questions will not carry any marks.
5. Write your registration number, your name and name of the examination centre at the specified locations on the right half of the **ORS**.
6. Using HB pencil, darken the appropriate bubble under each digit of your registration number and the letters corresponding to your paper code.
7. Calculator is allowed in the examination hall.
8. Charts, graph sheets or tables are **NOT** allowed in the examination hall.
9. Rough work can be done on the question paper itself. Additionally blank pages are given at the end of the question paper for rough work.
10. This question paper contains **32** printed pages including pages for rough work. Please check all pages and report, if there is any discrepancy.

Q. 1 – Q. 20 carry one mark each.

Q.1 Let A be an $n \times n$ real matrix such that $A^2 = I$ and y be an n -dimensional vector. Then the linear system of equations $Ax = y$ has

- (A) no solution
- (B) a unique solution
- (C) more than one but finitely many independent solutions
- (D) infinitely many independent solutions

Q.2 Let $j = \sqrt{-1}$. Then one value of j^j is

- (A) \sqrt{j}
- (B) -1
- (C) $\pi/2$
- (D) $e^{-\pi/2}$

Q.3 In full sunlight, a solar cell has a short circuit current of 75 mA and a current of 70 mA for a terminal voltage of 0.6 V with a given load. The Thevenin resistance of the solar cell is

- (A) 8 Ω
- (B) 8.6 Ω
- (C) 120 Ω
- (D) 240 Ω

Q.4 The DC voltage gain $\frac{V_o}{V_i}$ in the following circuit is given by

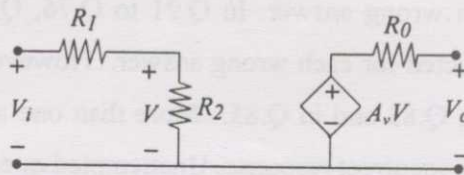

- (A) $A_v \frac{R_2}{R_1 + R_2}$
- (B) $A_v \frac{R_1}{R_1 + R_2}$
- (C) $A_v \frac{R_2}{R_1 + R_2} + R_o$
- (D) A_v

Q.5 Match the essential amplifier characteristics with the sensing applications given below:

Amplifier Characteristics

Sensing Applications

P. Charge amplifier with very low bias current and high input impedance

L. Strain gauge in unipolar DC Wheatstone bridge

Q. Voltage amplifier with low bias current and very high input impedance

M. Glass electrode pH sensor

R. Voltage amplifier with very high CMRR

N. Piezoelectric sensor for measurement of static force

- (A) P-L, Q-M, R-N
- (C) P-N, Q-L, R-M

- (B) P-M, Q-N, R-L
- (D) P-N, Q-M, R-L

- Q.6 The figure below shows various configurations of bonding a strain gauge to a cantilever subjected to a bending force F .

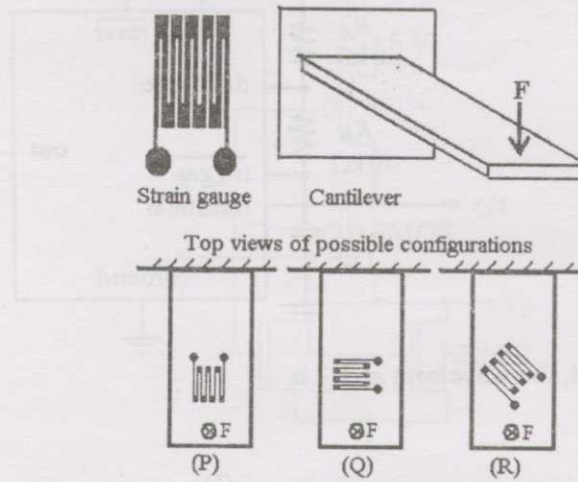

Which configuration gives the maximum change in resistance for this force?

- (A) P
 (B) Q
 (C) R
 (D) All have equal change in resistance
- Q.7 When light falls on the photodiode shown in the following circuit, the reverse saturation current of the photodiode changes from $100 \mu\text{A}$ to $200 \mu\text{A}$.

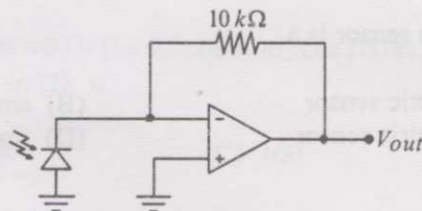

Assuming the op-amp to be ideal, the output voltage, V_{out} , of the circuit

- (A) does not change
 (B) changes from 1 V to 2 V
 (C) changes from 2 V to 1 V
 (D) changes from -1 V to -2 V

Q.8 A 555 astable multivibrator circuit is shown in the figure below:

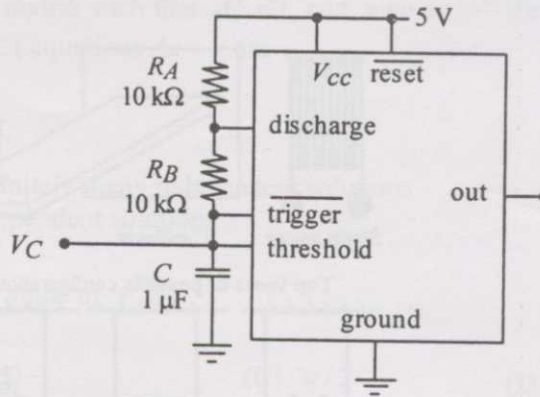

If R_B is shorted, the waveform at V_C is

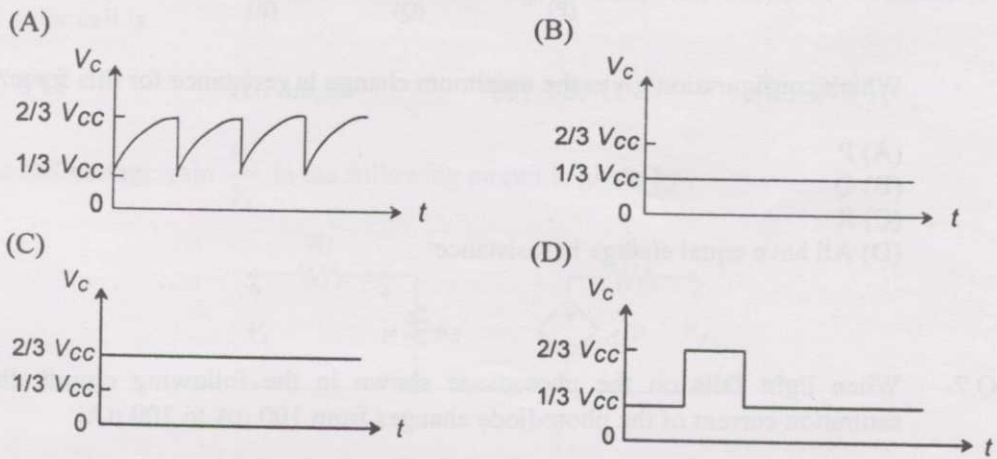

Q.9 A Clark oxygen sensor is a

- (A) potentiometric sensor (B) amperometric sensor
(C) conductometric sensor (D) magnetostrictive sensor

Q.10 A logic circuit implements the boolean function $F = \bar{X} \cdot Y + X \cdot \bar{Y} \cdot \bar{Z}$. It is found that the input combination $X=Y=1$ can never occur. Taking this into account, a simplified expression for F is given by

- (A) $\bar{X} + \bar{Y} \cdot \bar{Z}$ (B) $X + Z$ (C) $X + Y$ (D) $Y + X \cdot \bar{Z}$

Q.11 A CMOS implementation of a logic gate is shown in the following figure:

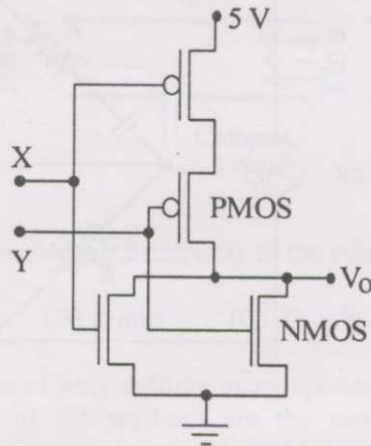

The boolean logic function realized by the circuit is

- (A) AND (B) NAND (C) NOR (D) OR

Q.12 Let $x(t)$ be a continuous-time, real-valued signal band-limited to F Hz. The Nyquist sampling rate, in Hz, for $y(t) = x(0.5t) + x(t) - x(2t)$ is

- (A) F (B) $2F$ (C) $4F$ (D) $8F$

Q.13 Consider the periodic signal $x(t) = (1 + 0.5 \cos 40\pi t) \cos 200\pi t$, where t is in seconds. Its fundamental frequency, in Hz, is

- (A) 20 (B) 40 (C) 100 (D) 200

Q.14 A dynamometer type wattmeter with a single scale marked for the smallest power range, has two current ranges, namely, 0-5 A and 0-10 A as well as two voltage ranges, namely, 0-150 V and 0-300 V. To carry out a load test on a 230 V / 115 V, 1kVA, single phase transformer, the wattmeter is used on the high voltage side. The voltage and current ranges are chosen for maximum utilization of the scale. The multiplying factor to be used in this case is

- (A) 0.5 (B) 1.0 (C) 2.0 (D) 4.0

- Q.15 Consider the AC bridge shown in the figure below, with A , L and C having positive finite values.

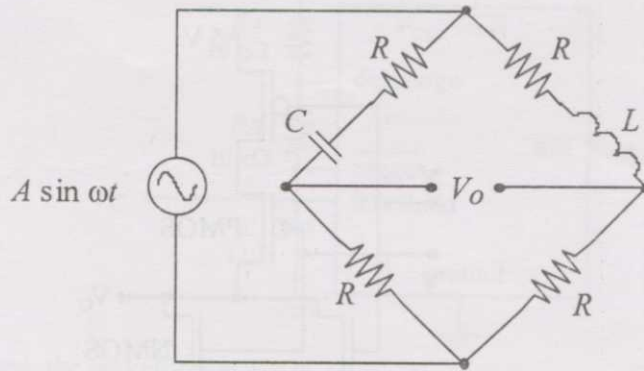

Then

- (A) $V_o = 0$ if $\omega L = \frac{1}{\omega C}$ (B) $V_o = 0$ if $L = C$
 (C) $V_o = 0$ if $R = \frac{1}{\omega\sqrt{LC}}$ (D) V_o cannot be made zero

- Q.16 A feedback control system with high gain K , is shown in the figure below:

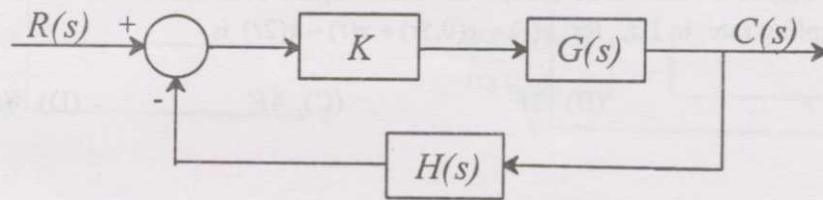

Then the closed loop transfer function is

- (A) sensitive to perturbations in $G(s)$ and $H(s)$
 (B) sensitive to perturbations in $G(s)$ but not to perturbations in $H(s)$
 (C) sensitive to perturbations in $H(s)$ but not to perturbations in $G(s)$
 (D) insensitive to perturbations in $G(s)$ and $H(s)$
- Q.17 Consider the following standard state-space description of a linear time-invariant single input single output system: $\dot{x} = Ax + Bu$, $y = Cx + Du$. Which one of the following statements about the transfer function CANNOT be true if $D \neq 0$?
- (A) The system is unstable (B) The system is strictly proper
 (C) The system is low pass (D) The system is of type zero

- Q.18 During intravascular measurement of arterial blood pressure, catheters may be introduced in different configurations, as shown in the figures below:

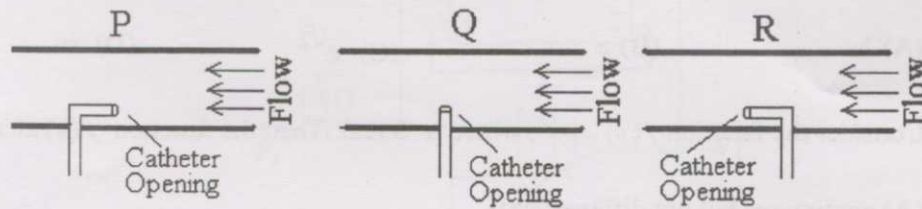

The static pressure will be measured correctly in the configuration(s)

- (A) P and Q but not in R (B) R only (C) Q only (D) P and R but not in Q
- Q.19 In N_2 -washout estimation of lung volume using spirometry, the lung volumes at the beginning and the end of the washout are the same. Let T , V , and F denote temperature, volume and molar fraction (of N_2) respectively; subscripts S and L denote the spirometer and the lung; and t_1 and t_2 the beginning time and the end time of the experiment, respectively. Then

(A) $V_L = \frac{T_L}{T_S} \left[\frac{F_S(t_2)V_S(t_2)}{F_L(t_1) - F_L(t_2)} \right]$ (B) $V_L = \frac{T_L}{T_S} \left[\frac{F_L(t_2)V_S(t_2)}{F_L(t_1) - F_L(t_2)} \right]$

(C) $V_L = F_L(t_1)V_L(t_2)$ (D) $V_L = T_S F_S(t_2)V_S(t_2)$

- Q.20 The dispersion in an X-ray diffractometer, $\frac{d\theta}{d\lambda}$, is given by the expression

(A) $\frac{m}{2d \cos \theta}$ (B) $\frac{m}{2d \sin \theta}$ (C) $2d \sin \theta$ (D) $2d \cos \theta$

Q. 21 to Q. 75 carry two marks each.

- Q.21 The polynomial $p(x) = x^5 + x + 2$ has

- (A) all real roots (B) 3 real and 2 complex roots
 (C) 1 real and 4 complex roots (D) all complex roots

- Q.22 Let $A = [a_{ij}]$, $1 \leq i, j \leq n$, with $n \geq 3$ and $a_{ij} = i \cdot j$. Then the rank of A is

- (A) 0 (B) 1 (C) $n-1$ (D) n

- Q.23 For real x , the maximum value of $\frac{e^{\sin x}}{e^{\cos x}}$ is
- (A) 1 (B) e (C) $e^{\sqrt{2}}$ (D) ∞
- Q.24 Consider the function $f(x) = |x|^3$, where x is real. Then the function $f(x)$ at $x = 0$ is
- (A) continuous but not differentiable
 (B) once differentiable but not twice
 (C) twice differentiable but not thrice
 (D) thrice differentiable
- Q.25 The value of the integral $\int_0^\infty \int_0^\infty e^{-x^2} e^{-y^2} dx dy$ is
- (A) $\sqrt{\pi}/2$ (B) $\sqrt{\pi}$ (C) π (D) $\pi/4$
- Q.26 For the function $\frac{\sin z}{z^3}$ of a complex variable z , the point $z = 0$ is
- (A) a pole of order 3 (B) a pole of order 2
 (C) a pole of order 1 (D) not a singularity
- Q.27 Assume that the duration in minutes of a telephone conversation follows the exponential distribution $f(x) = \frac{1}{5} e^{-x/5}$, $x \geq 0$. The probability that the conversation will exceed five minutes is
- (A) $\frac{1}{e}$ (B) $1 - \frac{1}{e}$ (C) $\frac{1}{e^2}$ (D) $1 - \frac{1}{e^2}$
- Q.28 The boundary-value problem $y'' + \lambda y = 0$, $y(0) = y(\pi) = 0$ will have non-zero solutions if and only if the values of λ are
- (A) $0, \pm 1, \pm 2, \dots$ (B) $1, 2, 3, \dots$
 (C) $1, 4, 9, \dots$ (D) $1, 9, 25, \dots$
- Q.29 Identify the Newton-Raphson iteration scheme for finding the square root of 2.
- (A) $x_{n+1} = \frac{1}{2} \left(x_n + \frac{2}{x_n} \right)$ (B) $x_{n+1} = \frac{1}{2} \left(x_n - \frac{2}{x_n} \right)$
 (C) $x_{n+1} = \frac{2}{x_n}$ (D) $x_{n+1} = \sqrt{2 + x_n}$

Q.30 Consider the linear circuit with an ideal op-amp shown in the figure below.

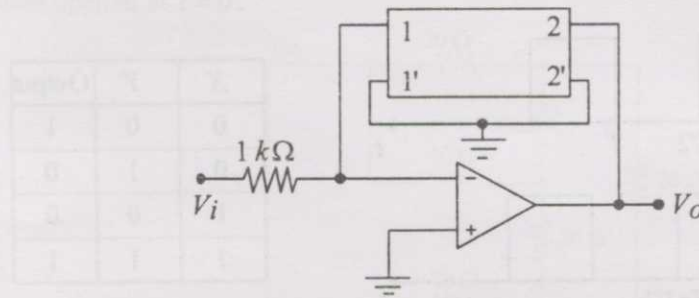

The Z-parameters of the two port feedback network are $Z_{11} = Z_{22} = 11 \text{ k}\Omega$ and $Z_{12} = Z_{21} = 1 \text{ k}\Omega$. The gain of the amplifier is

- (A) +110 (B) +11 (C) -1 (D) -120

Q.31 Consider a non-ideal voltage source whose output voltage is measured by a non-ideal voltmeter as shown below.

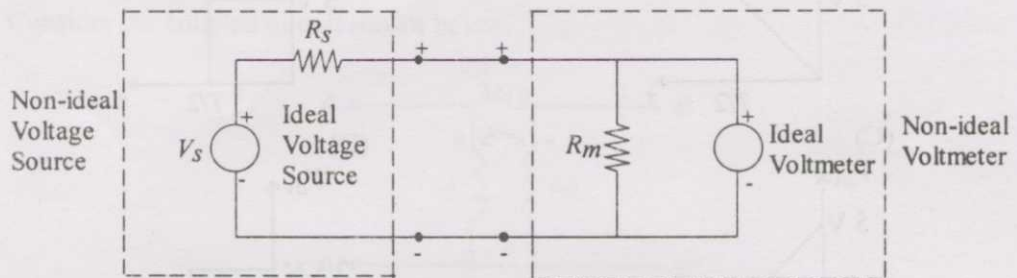

Let V_e be the difference between V_s and the measured voltage.

Then $\frac{V_e}{V_s}$ is a function of

- (A) R_m only (B) R_s only
 (C) $\frac{R_s}{R_m}$ (D) $R_m - R_s$

Q.32 Two sensors have measurement errors that are Gaussian distributed with zero means and variances σ_1^2 and σ_2^2 , respectively. The two sensor measurements x_1 and x_2 are combined to form the weighted average $x = \alpha x_1 + (1 - \alpha)x_2$, $0 \leq \alpha \leq 1$. Assuming that the measurement errors of the two sensors are uncorrelated, the weighting factor α that yields the smallest error variance of x is

- (A) $\frac{\sigma_2^2}{\sigma_1^2 + \sigma_2^2}$ (B) $\frac{\sigma_1^2}{\sigma_1^2 + \sigma_2^2}$ (C) $\frac{\sigma_2}{\sigma_1 + \sigma_2}$ (D) 0.5

- Q.33 Two square waves of equal period T , but with a time delay τ are applied to a digital circuit whose truth table is shown in the following figure.

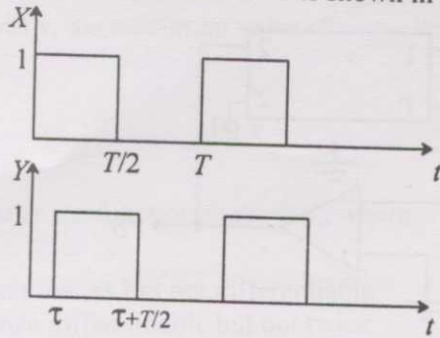

X	Y	Output
0	0	1
0	1	0
1	0	0
1	1	1

The high and the low levels of the output of the digital circuit are 5 V and 0 V, respectively. Which one of the following figures shows the correct variation of the average value of the output voltage as a function of τ for $0 \leq \tau \leq (T/2)$?

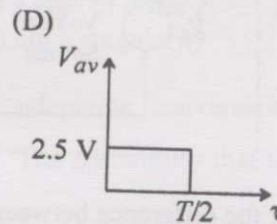
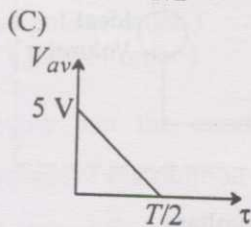
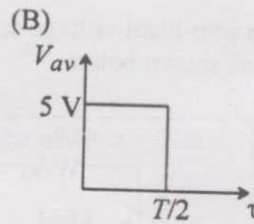
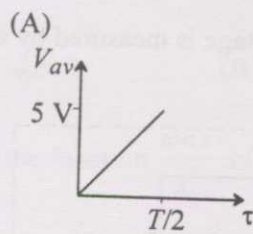

- Q.34 In the circuit shown in the following figure, the current through the 1Ω resistor is

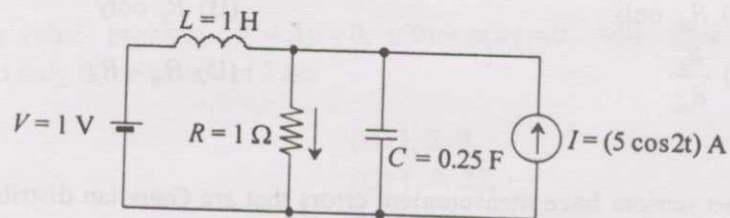

- (A) $(1 + 5 \cos 2t)$ A
 (C) $(1 - 5 \cos 2t)$ A

- (B) $(5 + \cos 2t)$ A
 (D) 6 A

- Q.35 In the circuit shown in the following figure, the switch is kept closed for a long time and then opened at $t = 0$.

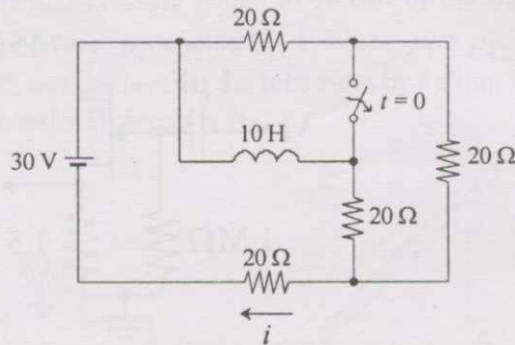

The values of the current i just before opening the switch ($t = 0^-$) and just after opening the switch ($t = 0^+$) are, respectively

- (A) $\frac{3}{4}$ A and 1 A (B) $\frac{3}{4}$ A and $\frac{5}{2}$ A (C) 1 A and $\frac{7}{6}$ A (D) 1 A and 1 A
- Q.36 Consider the coupled circuit shown below.

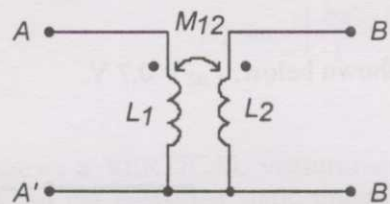

At angular frequency ω , this circuit can be represented by the equivalent T-network, shown below.

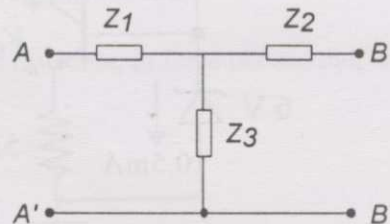

Indicate the correct set of expressions for the impedances of the T-network.

- | | | | |
|-------------------------------|-------------------------------|-------------------------|-------------------------------------|
| (A) | (B) | (C) | (D) |
| $Z_1 = j\omega(L_1 - M_{12})$ | $Z_1 = j\omega(L_1 + M_{12})$ | $Z_1 = j\omega L_1$ | $Z_1 = j\omega(L_1 - M_{12})$ |
| $Z_2 = j\omega(L_2 - M_{12})$ | $Z_2 = j\omega(L_2 + M_{12})$ | $Z_2 = j\omega L_2$ | $Z_2 = j\omega(L_2 - M_{12})$ |
| $Z_3 = j\omega M_{12}$ | $Z_3 = j\omega M_{12}$ | $Z_3 = -j\omega M_{12}$ | $Z_3 = j\omega(L_1 + L_2 + M_{12})$ |

Q.37 A FET source follower is shown in the figure below:

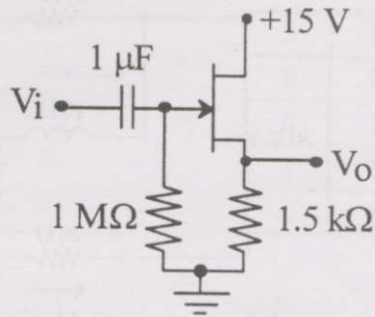

The nature of feedback in this circuit is

- (A) positive current
- (B) negative current
- (C) positive voltage
- (D) negative voltage

Q.38 In the circuit shown below, $V_{BE} = 0.7$ V.

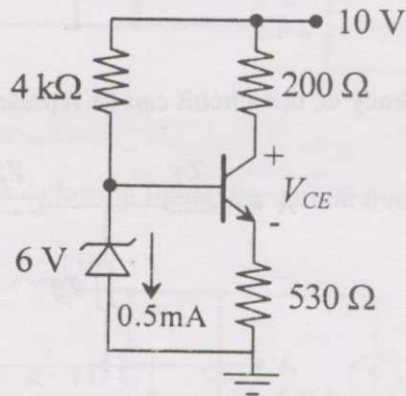

The β of the transistor and V_{CE} are, respectively

- (A) 19 and 2.8 V
- (B) 19 and 4.7 V
- (C) 38 and 2.8 V
- (D) 38 and 4.7 V

- Q.39 A well of cross-sectional area a_w is connected to an inclined tube of cross-sectional area a_t to form a differential pressure gauge as shown in the figure below. When $p_1 = p_2$ the common liquid level is denoted by A. When $p_1 > p_2$, the liquid level in the well is depressed to B, and the level in the tube rises by l along its length such that the difference in the tube and well levels is h_d .

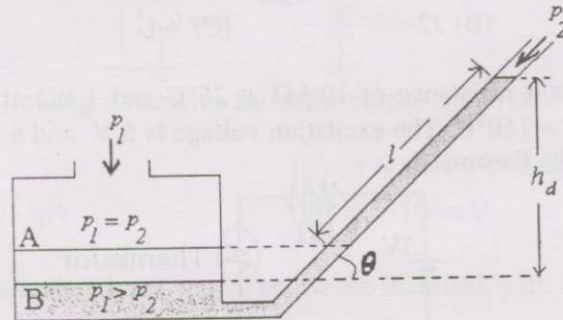

The angle of inclination θ of the tube with the horizontal is

- (A) $\sin^{-1} \left[\frac{l}{h_d} - \frac{a_w}{a_t} \right]$ (B) $\sin^{-1} \left[\frac{h_d}{l} + \frac{a_t}{a_w} \right]$
 (C) $\sin^{-1} \left[\frac{h_d}{l} - \frac{a_t}{a_w} \right]$ (D) $\sin^{-1} \left[\frac{h_d}{l} - \frac{a_w}{a_t} \right]$
- Q.40 The accompanying figure shows a VERTICAL venturimeter with upward water flow. When the measured static pressure difference, $p_1 - p_2$, between the inlet and the throat is 30 kPa, the flow rate is found to be 50 litres per second. Assume that the coefficient of discharge remains the same.

When $p_1 - p_2 = 20$ kPa, the flow rate, in litres per second, is

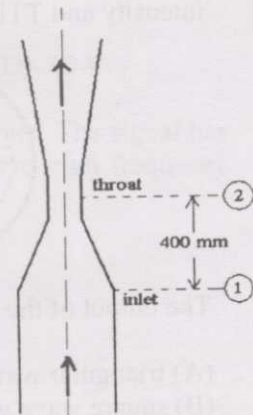

- (A) 33.3 (B) 39.3 (C) 40.8 (D) 54.2
- Q.41 A thermometer with time constant τ , initially at the ambient temperature, is used to measure the temperature of a liquid in a bath. The excess temperature of the thermometer and the liquid over the ambient are $\theta(t)$ and $\theta_l(t)$, respectively, where t denotes the time. If $\theta_l(t) = kt$, where k is a constant, the steady state error, defined as $\lim_{t \rightarrow \infty} [\theta(t) - \theta_l(t)]$, is
- (A) ∞ (B) 0 (C) $-k$ (D) $-k\tau$

Q.42 In a laminar flow experiment, Fluid A is pumped through a straight tube and the volumetric flow rate and pressure drop per unit length are recorded. In a second straight tube having twice the internal diameter of the first one, Fluid B records the same pressure drop per unit length at the same volumetric flow rate. Assuming fully developed flow conditions in the tubes, the ratio of the dynamic viscosity of Fluid B to that of Fluid A is

- (A) 16 (B) 32 (C) 64 (D) 128

Q.43 A thermistor has a resistance of $10\text{ k}\Omega$ at 25°C and $1\text{ k}\Omega$ at 100°C . The range of operation is $0^\circ\text{C} - 150^\circ\text{C}$. The excitation voltage is 5 V and a series resistor of $1\text{ k}\Omega$ is connected to the thermistor.

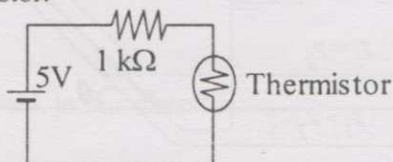

The power dissipated in the thermistor at 150°C is

- (A) 4.0 mW (B) 4.7 mW (C) 5.4 mW (D) 6.1 mW

Q.44 A measurement system for the rotational speed of a motor is shown in the figure below. The system consists of an opaque disk attached to the motor shaft with a hole as shown. A light source and a photodetector are placed on two sides of the disk so that whenever the hole crosses the light path, the photodetector receives light through the hole. The photodetector circuit is also shown below. Assume sufficient light intensity and TTL logic levels for the inverter.

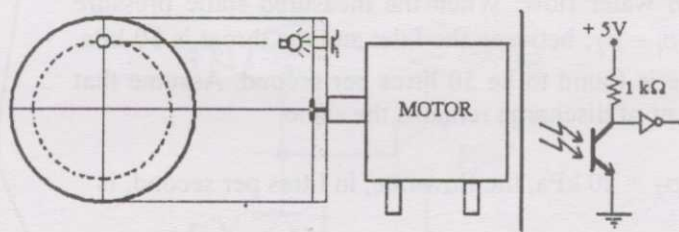

The output of the photodetector is a

- (A) triangular wave
 (B) square wave with 50% duty cycle
 (C) rectangular wave with duty cycle close to unity
 (D) rectangular wave with duty cycle close to zero

Q.45 A pH electrode, being used at 25°C , has a source resistance of $10^{10}\ \Omega$. The electrode obeys the Nernst equation perfectly. The electronic voltmeter, with which the potential is being measured, has an input impedance of $10^{11}\ \Omega$ and a gain of 100. If the pH of the analyte changes from 6.5 to 7.8, the change in voltage observed on the voltmeter is

- (A) less than 6.8 V (B) between 6.8 V and 7.19 V
 (C) between 7.2 V and 7.49 V (D) greater than 7.49 V

Q.46 The figure shows a single op-amp differential amplifier circuit.

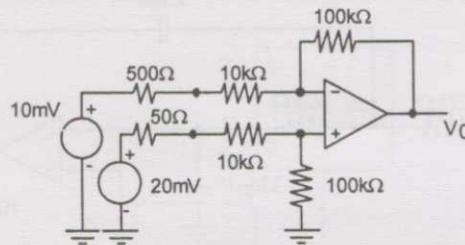

Which one of the following statements about the output is correct?

- (A) $V_o \leq 95 \text{ mV}$ (B) $95 \text{ mV} < V_o \leq 98 \text{ mV}$
 (C) $98 \text{ mV} < V_o \leq 101 \text{ mV}$ (D) $V_o > 101 \text{ mV}$

Q.47 The three transistors in the circuit shown below are identical, with $V_{BE} = 0.7 \text{ V}$ and $\beta = 100$.

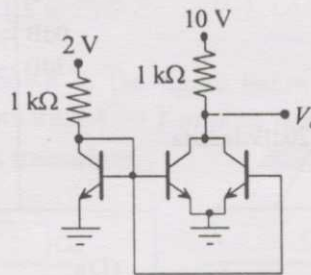

The voltage V_c is

- (A) 0.2 V (B) 2 V (C) 7.4 V (D) 10 V

Q.48 The input signal shown in the figure below is fed to a Schmitt trigger. The signal has a square wave amplitude of 6 V p-p. It is corrupted by an additive high frequency noise of amplitude 8 V p-p.

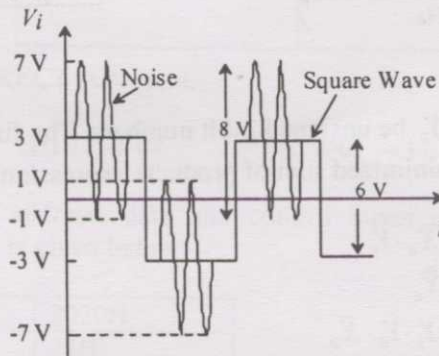

Which one of the following is an appropriate choice for the upper and lower trip points of the Schmitt trigger to recover a square wave of the same frequency from the corrupted input signal V_i ?

- (A) $\pm 8.0 \text{ V}$ (B) $\pm 2.0 \text{ V}$ (C) $\pm 0.5 \text{ V}$ (D) 0 V

Q.49 Consider the circuit shown below.

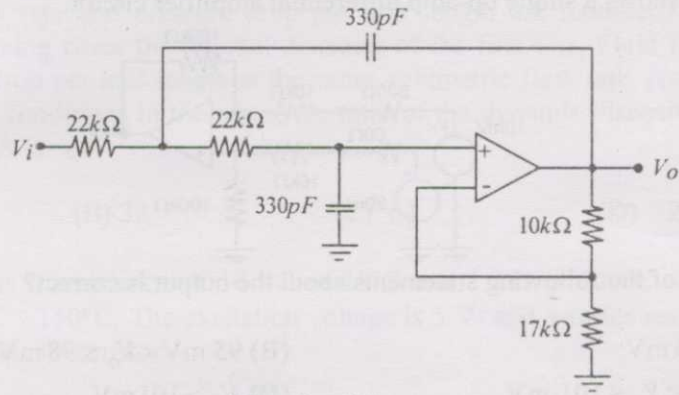

The correct frequency response of the circuit is

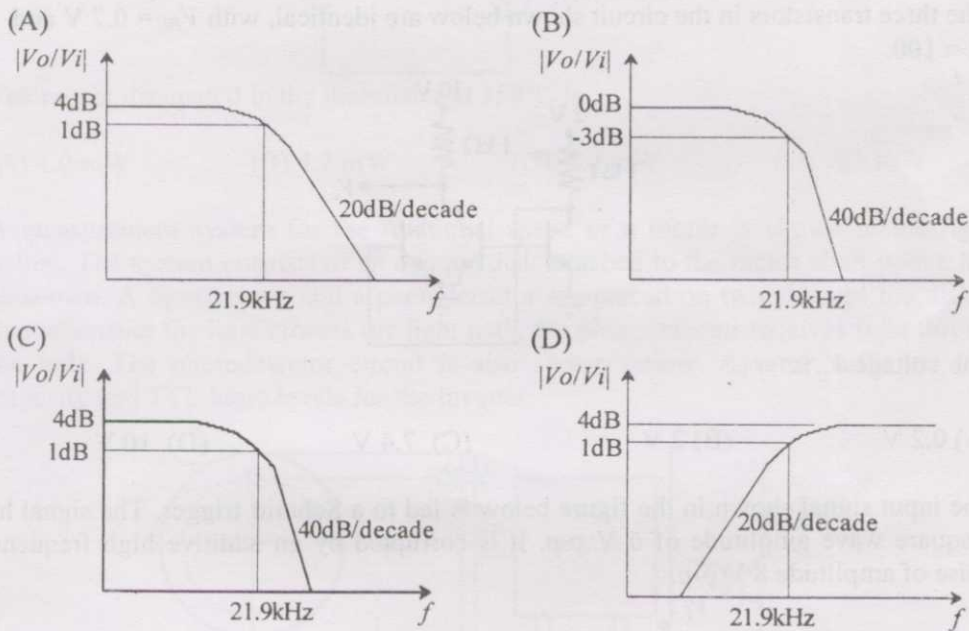

Q.50 Let $X = X_1X_0$ and $Y = Y_1Y_0$ be unsigned 2-bit numbers. The function $F = 1$ if $X > Y$ and $F = 0$ otherwise. The minimized sum of products expression for F is

- (A) $Y_1 \cdot Y_0 + X_0 \cdot Y_0 + \bar{X}_1 \cdot \bar{X}_0 \cdot \bar{Y}_1$
- (B) $X_0 \cdot \bar{Y}_1 + Y_1 \cdot \bar{Y}_0 + X_1 \cdot \bar{X}_0$
- (C) $Y_1 \cdot \bar{X}_1 + Y_0 \cdot \bar{X}_1 \cdot \bar{X}_0 + Y_1 \cdot Y_0 \cdot \bar{X}_0$
- (D) $X_1 \cdot \bar{Y}_1 + X_0 \cdot \bar{Y}_0 \cdot \bar{Y}_1 + X_0 \cdot X_1 \cdot \bar{Y}_0$

Q.51 A MUX circuit shown in the figure below implements a logic function F_1 .

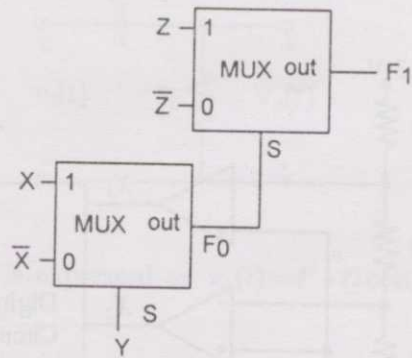

The correct expression for F_1 is

- (A) $\overline{(X \oplus Y)} \oplus Z$ (B) $\overline{(X \oplus Y)} \oplus Z$ (C) $(X \oplus Y) \oplus \bar{Z}$ (D) $(X \oplus Y) + Z$

Q.52 A sequential circuit is shown in the figure below. Let the state of the circuit be encoded as $Q_A Q_B$. The notation $X \rightarrow Y$ implies that state Y is reachable from state X in a finite number of clock transitions.

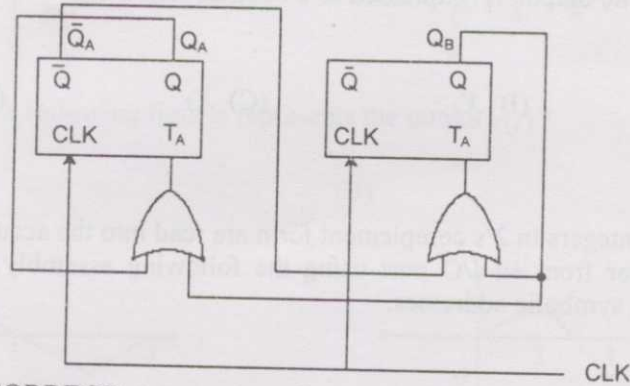

Identify the INCORRECT statement.

- (A) $01 \rightarrow 00$ (B) $11 \rightarrow 01$ (C) $01 \rightarrow 11$ (D) $01 \rightarrow 10$

Q.53 A snapshot of the address, data and control buses of an 8085 microprocessor executing a program is given below:

Address	2020H
Data	24H
$\text{IO}/\bar{\text{M}}$	Logic High
$\overline{\text{RD}}$	Logic High
$\overline{\text{WR}}$	Logic Low

The assembly language instruction being executed is

- (A) IN 24H (B) IN 20H (C) OUT 24H (D) OUT 20H

- Q.54 The circuit shown in the figure below works as a 2-bit analog to digital converter for $0 \leq V_{in} \leq 3$ V.

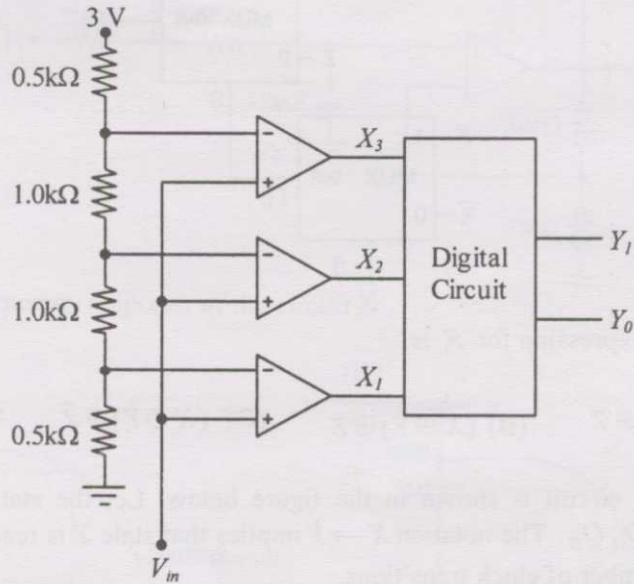

The MSB of the output Y_1 , expressed as a boolean function of the inputs X_1, X_2, X_3 is given by

- (A) X_1 (B) X_2 (C) X_3 (D) $X_1 + X_2$
- Q.55 8-bit signed integers in 2's complement form are read into the accumulator of an 8085 microprocessor from an I/O port using the following assembly language program segment with symbolic addresses.

```
BEGIN:  IN PORT
        RAL
        JNC  BEGIN
        RAR
END:    HLT
```

This program

- (A) halts upon reading a negative number
 (B) halts upon reading a positive number
 (C) halts upon reading a zero
 (D) never halts

Q.56 In the circuit shown in the figure, the input signal is $v_i(t) = 5 + 3 \cos \omega t$.

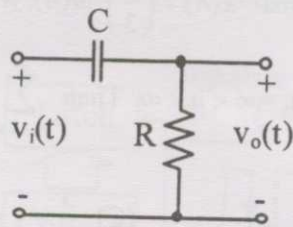

The steady-state output is expressed as $v_o(t) = P + Q \cos(\omega t - \phi)$. If $\omega CR = 2$, the values of P and Q are

- (A) $P = 0$ and $Q = 6/\sqrt{5}$ (B) $P = 0$ and $Q = 3/\sqrt{5}$
 (C) $P = 5$ and $Q = 6/\sqrt{5}$ (D) $P = 5$ and $Q = 3$

Q.57 The signals $x(t)$ and $h(t)$ shown in the figures are convolved to yield $y(t)$.

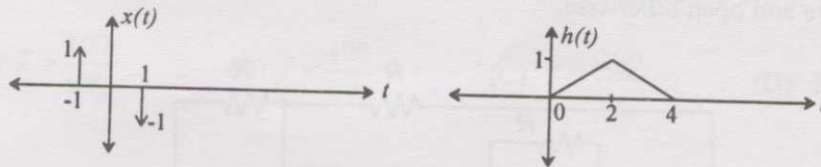

Which one of the following figures represents the output $y(t)$?

(A)

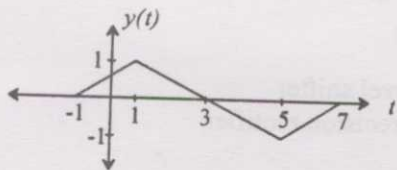

(B)

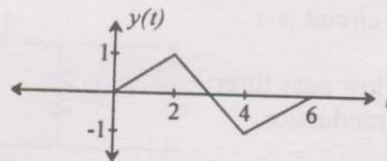

(C)

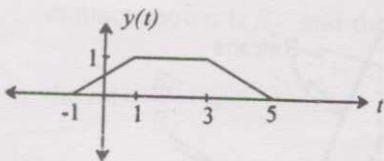

(D)

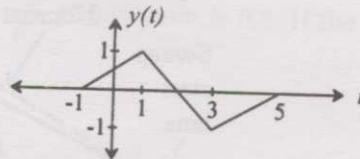

Q.58

Consider the discrete-time signal $x(n) = \left(\frac{1}{3}\right)^n u(n)$, where $u(n) = \begin{cases} 1, & n \geq 0 \\ 0, & n < 0 \end{cases}$. Define

the signal $y(n)$ as $y(n) = x(-n)$, $-\infty < n < \infty$. Then $\sum_{n=-\infty}^{\infty} y(n)$ equals

- (A) $-\frac{2}{3}$ (B) $\frac{2}{3}$ (C) $\frac{3}{2}$ (D) 3

Q.59 Let the signal $x(t)$ have the Fourier transform $X(\omega)$. Consider the signal $y(t) = \frac{d}{dt}[x(t-t_d)]$ where t_d is an arbitrary delay. The magnitude of the Fourier transform of $y(t)$ is given by the expression

- (A) $|X(\omega)| \cdot |\omega|$ (B) $|X(\omega)| \cdot \omega$ (C) $\omega^2 \cdot |X(\omega)|$ (D) $|\omega| \cdot |X(\omega)| \cdot e^{-j\omega t_d}$

Q.60 In the circuit shown below the switch (S) is closed whenever the input voltage (V_{in}) is positive and open otherwise.

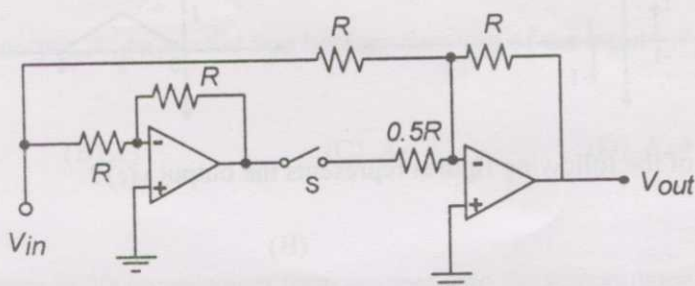

The circuit is a

- (A) low pass filter (B) level shifter
(C) modulator (D) precision rectifier

Q.61 The linear sweep for the time base in an oscilloscope has deviation from its nominal waveform. The nominal (dashed line) and actual (solid line) sweep waveforms are shown in the following figure.

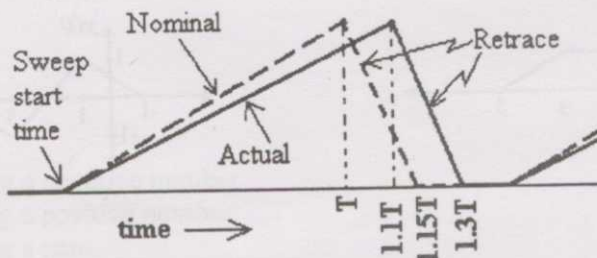

A 5V p-p sine wave with a frequency of 1 kHz will be measured on the oscilloscope as a sine wave with

- (A) 4.45 V p-p and 1 kHz frequency (B) 5 V p-p and 1 kHz frequency
(C) 5 V p-p and 1.1 kHz frequency (D) 5 V p-p and 1.15 kHz frequency

- Q.62 The pulse width T of an asynchronous pulse is measured by a counter with an edge-triggered clock of known frequency f_c as shown in the figure below:

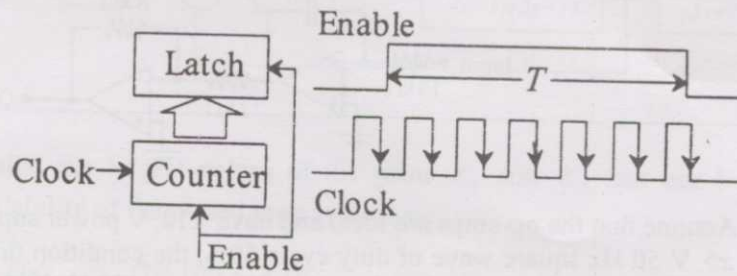

The pulse, whose width is to be measured, is applied to the Enable pin of the counter. The counter counts while the Enable is high and is held reset to zero otherwise. The counter output is latched by the negative edge of the Enable signal. The measured pulse width is taken to be N times the clock period, where N is the count reached at the end of a count cycle.

Assuming no overflow, the measurement error will be limited to $x\%$ of T if

- (A) $T > \frac{100}{xf_c}$ (B) $T < \frac{100}{xf_c}$ (C) $T > \frac{200}{xf_c}$ (D) $T < \frac{200}{xf_c}$

- Q.63 The figure shows a potentiometer of total resistance R_T with a sliding contact.

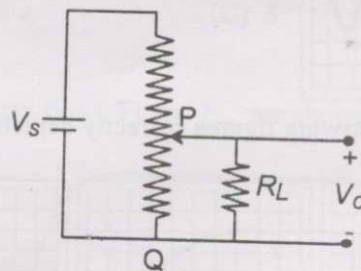

The resistance between the points P and Q of the potentiometer at the position of the contact shown is R_C and the voltage ratio $\frac{V_o}{V_s}$ at this point is 0.5. If the ratio $\frac{R_L}{R_T} = 1$, the ratio $\frac{R_C}{R_T}$ is

- (A) $\frac{-1+\sqrt{5}}{2}$ (B) $\frac{1+\sqrt{5}}{2}$ (C) $-1+\sqrt{5}$ (D) $1+\sqrt{5}$

Q.64 Consider the triangular wave generator shown below.

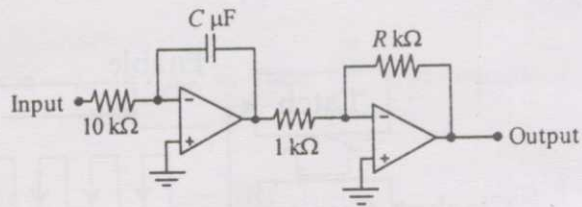

Assume that the op-amps are ideal and have ± 12 V power supply. If the input is a ± 5 V 50 Hz square wave of duty cycle 50%, the condition that results in a triangular wave of peak to peak amplitude 5 V and frequency 50 Hz at the output is

- (A) $RC = 1$ (B) $\frac{R}{C} = 1$ (C) $\frac{R}{C} = 5$ (D) $\frac{C}{R} = 5$

Q.65 Two signals of peak-to-peak voltages 5 V and 2 V are being fed to Channel 1 and Channel 2, respectively, of an oscilloscope with a single time base. The vertical sensitivity of both channels is 1 V/division. The two sine waves have identical frequency and phase. The trigger is on manual mode and triggers at a level of +1.25 V on Channel 1, as shown in the figure below:

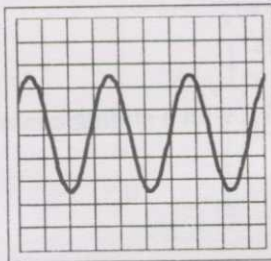

Trace for Channel 1

Which of the following figures correctly depicts the trace seen in Channel 2?

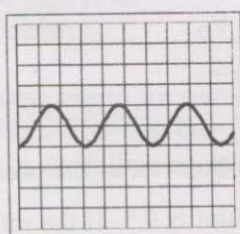

(P)

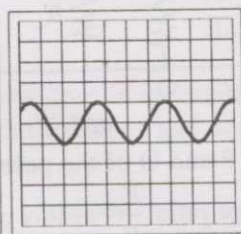

(Q)

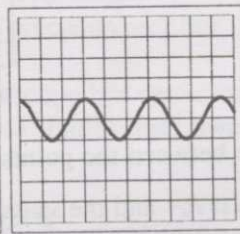

(R)

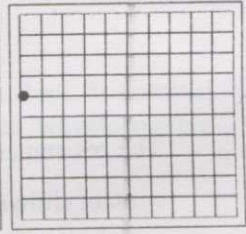

(S)

(A) P

(B) Q

(C) R

(D) S

Q.66 A chamber is heated with a heater of maximum power rating of 1000 W. The process transfer relationship between the steady-state heater power and chamber temperature is assumed to be linear with a slope of 2 Watts / $^{\circ}\text{C}$. The heater power is the sum of the output of a proportional controller having a proportional band of 200% and a constant offset of 500 W. The temperature achieved for a set point of 300°C is

(A) 260°C

(B) 60°C

(C) 275°C

(D) 150°C

Q.67 A cascade control system with proportional controllers is shown below.

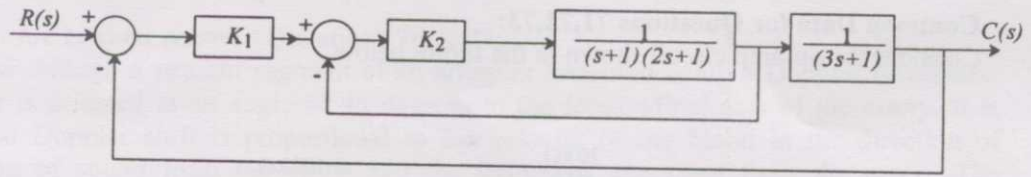

Theoretically, the largest values of the gains K_1 and K_2 that can be set without causing instability of the closed loop system are

- (A) 10 and 100 (B) 100 and 10 (C) 10 and 10 (D) ∞ and ∞

Q.68 The ECG of a patient is being recorded using the three standard frontal plane leads. If the cardiac vector is oriented at an angle of 45 degrees to Lead I and has a magnitude of 3 mV, the voltages seen on Leads I, II and III are

- (A) 1.50, 2.27, and 0.77 mV (B) 2.12, 0.77, and 2.89 mV
 (C) 2.12, 3.15, and 1.03 mV (D) 2.12, 2.89, and 0.77 mV

Q.69 Light of intensity I_0 is equally divided and passed through 2 cuvettes P_1 and P_2 containing an analyte at concentrations c and $0.5c$, respectively. The corresponding path lengths in P_1 and P_2 are 4 cm and 1 cm. The cross sectional areas are 1 cm^2 and 3 cm^2 , respectively. The ratio of the absorbances in P_1 and P_2 is

- (A) 1.5 (B) 8/3 (C) 3 (D) 8

Q.70 The H-D curves of two X-ray films, F_1 and F_2 , are shown below.

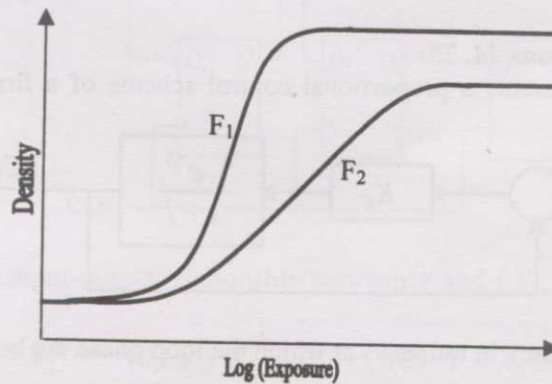

The curves show that, for the same change in exposure, F_1 has

- (A) higher contrast than F_2 but the same fog level
 (B) lower contrast than F_2 but the same fog level
 (C) higher contrast and higher fog level than F_2
 (D) lower contrast than F_2 but higher fog level

Common Data Questions

Common Data for Questions 71,72,73:

Consider the op-amp circuit shown in the figure below.

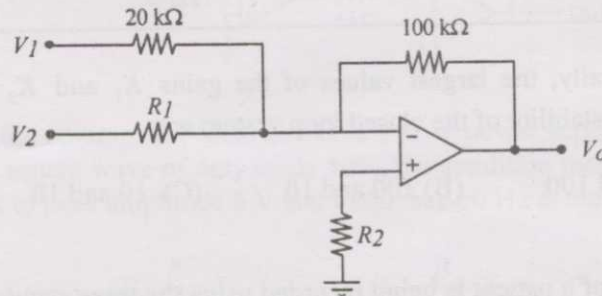

- Q.71 If $V_1 = 0.2 \text{ V}$, $V_2 = 0.6 \text{ V}$ and $V_o = -7 \text{ V}$, and the op-amp is ideal, the value of R_1 is
 (A) $5 \text{ k}\Omega$ (B) $10 \text{ k}\Omega$ (C) $15 \text{ k}\Omega$ (D) $20 \text{ k}\Omega$
- Q.72 Let $V_1 = V_2 = V_c \sin 2\pi ft$ and $R_1 = 20 \text{ k}\Omega$. The op-amp has a slew rate of $0.5 \text{ V}/\mu\text{s}$ with its other parameters being ideal. The values of V_c and f for which the amplifier output will have no distortion are, respectively
 (A) 0.1 V and 300 kHz (B) 0.5 V and 300 kHz
 (C) 0.1 V and 30 kHz (D) 0.5 V and 30 kHz
- Q.73 Let $V_1 = V_2 = 0$ and $R_1 = 20 \text{ k}\Omega$. Assume that the op-amp is ideal except for a non-zero input bias current. What is the value of R_2 for the output voltage of the op-amp to be zero?
 (A) $2.2 \text{ k}\Omega$ (B) $9.1 \text{ k}\Omega$ (C) $20 \text{ k}\Omega$ (D) $100 \text{ k}\Omega$

Common Data for Questions 74, 75:

The following figure represents a proportional control scheme of a first order system with transportation lag.

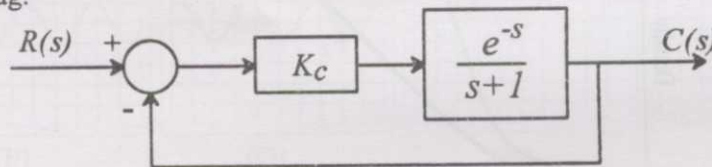

- Q.74 The angular frequency in radians/s at which the loop phase lag becomes 180° is
 (A) 0.408 (B) 0.818 (C) 1.56 (D) 2.03
- Q.75 The steady state error for a unit step input when the gain $K_c = 1$ is
 (A) $\frac{1}{4}$ (B) $\frac{1}{2}$ (C) 1 (D) 2

Linked Answer Questions: Q.76 to Q.85 carry two marks each.

Statement for Linked Answer Questions 76 & 77:

Blood flow through a straight segment of an artery is measured using a Doppler flowmeter. The probe is oriented at an angle of 45 degrees to the longitudinal axis of the artery. It is known that Doppler shift is proportional to the velocity of the blood in the direction of propagation of sound from the probe and the frequency generated from the probe. The velocity of sound in blood is 1500 m/s and the maximum blood flow velocity to be measured is 110 cm/s.

- Q.76 Signal processing limitations constrain the maximum Doppler shift to be less than 3 kHz. The maximum source frequency (probe output), to the nearest MHz, should be
- (A) 2 MHz (B) 3 MHz (C) 5 MHz (D) 10 MHz
- Q.77 In Q.76, if the piezoelectric crystal of the probe is made of quartz (Young's modulus, $Y = 80 \times 10^9 \text{ N.m}^{-2}$, $\rho = 2.65 \times 10^3 \text{ kg.m}^{-3}$), the maximum thickness of the crystal required to resonate at the frequency determined above, to the nearest mm, is
- (A) 1 mm (B) 2 mm (C) 3 mm (D) 4 mm

Statement for Linked Answer Questions 78 & 79:

Consider the circuit shown in the following figure.

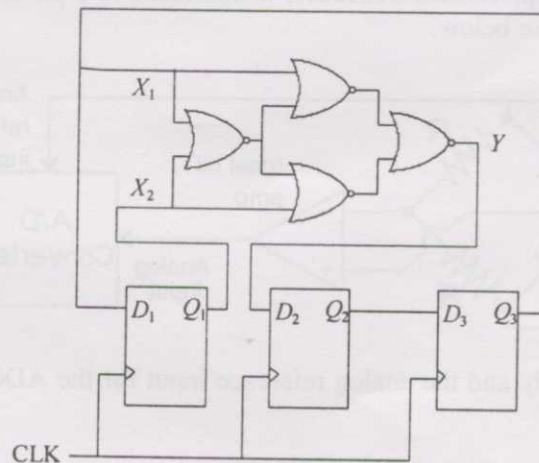

- Q.78 The correct input-output relationship between Y and (X_1, X_2) is
- (A) $Y = X_1 + X_2$ (B) $Y = X_1 X_2$ (C) $Y = X_1 \oplus X_2$ (D) $Y = \overline{X_1 \oplus X_2}$
- Q.79 The D flip-flops are initialized to $Q_1 Q_2 Q_3 = 000$. After 1 clock cycle, $Q_1 Q_2 Q_3$ is equal to
- (A) 011 (B) 010 (C) 100 (D) 101

Statement for Linked Answer Questions 80 & 81:

The numerical aperture of a step index fiber in air (refractive index = 1) is 0.39. The diameter of the core is $200 \mu\text{m}$.

- Q.80 The angle of acceptance when the fiber is used in water (refractive index = 1.33) is closest to
- (A) 15° (B) 16° (C) 17° (D) 18°
- Q.81 Two experiments are conducted in which light is launched into the fiber from a uniformly distributed planar source kept 5 mm away from the tip. In the first experiment (E_1) both the source and the fiber are in air. In the second experiment (E_2) both the source and the fiber are in water. Neglecting absorption in the medium between the source and the tip, the ratio of the amount of light coupled into the fiber in E_1 to the amount of light coupled into the fiber in E_2 is closest to
- (A) 0.5 (B) 1.0 (C) 1.4 (D) 1.9

Statement for Linked Answer Questions 82 & 83:

A push-pull capacitive displacement transducer is interfaced to a differential amplifier and an ADC as shown in the figure below.

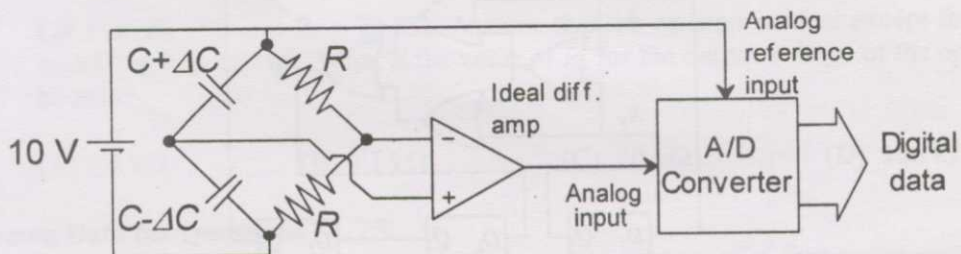

Note that the bridge supply and the analog reference input for the ADC are derived from the same 10 V DC source.

- Q.82 The change in capacitance for full scale displacement is $\pm 5\%$ for the capacitors. The gain of the differential amplifier for utilization of the full range of the ADC (which is $\pm 10 \text{ V}$) is
- (A) 10 (B) 20 (C) 30 (D) 40
- Q.83 If the supply voltage to the bridge decreases by 5%, the sensitivity of the measurement system
- (A) decreases by 5% (B) does not change
(C) increases by 5% (D) increases by 200%

Statement for Linked Answer Questions 84 & 85:

A transfer function with unity DC gain has three poles at -1, -2, and -3 and no finite zeros. A plant with this transfer function is connected with a proportional controller of gain K in the forward path, in a unity feedback configuration.

Q.84 The transfer function is

(A) $\frac{s}{(s-1)(s-2)(s-3)}$

(B) $\frac{6}{(s+1)(s+2)(s+3)}$

(C) $\frac{s}{(s+1)(s+2)(s+3)}$

(D) $\frac{6}{(s-1)(s-2)(s-3)}$

Q.85 If the root locus plot of the closed loop system passes through the points $\pm j\sqrt{11}$, the maximum value of K for stability of the unity feedback closed loop system is

(A) $\sqrt{11}$

(B) 6

(C) 10

(D) $6\sqrt{11}$

END OF THE QUESTION PAPER